

We sincerely hope your spa life is a pleasant experience. If problems should arise, contact your authorized Marquis Spas® dealer. Or contact Marquis Corp. at any of the following:

Email: service@marquiscorp.com
 Web: www.marquisspas.com
 Marquis Corp.
 596 Hoffman Road
 Independence, OR 97351, USA

This manual is provided to enhance your enjoyment of your spa and to prevent non-warranty situations. It is your sole responsibility to read, understand and comply with the instructions in the owner's manual. Please save your original sales receipt for reference in case of a future warranty claim. Failure to use, maintain or install the spa in compliance with this owner's manual could result in loss of warranty coverage.

PRODUCT REFERENCE

SERIAL NUMBER LOCATION

You will find the serial number in the equipment area.

PLEASE FILL OUT AND KEEP FOR FUTURE REFERENCE

Name of Purchaser _____

Date of Purchase _____

Address _____

City _____ Country/Province _____

Postal Code _____

Spa Model/Colour _____

Spa Serial No. _____

Pack Serial No. _____

Dealer's Name _____

Dealer's Address _____

City _____ Country/Province _____

Postal Code _____

Telephone _____

Every effort has been made to ensure the accuracy of this manual. However, Marquis Spas® reserves the right to improve its product without notice. This could create a minor variation between this manual and the actual product you receive. We apologize for any inconvenience this may cause.

SEPARATE WASTE COLLECTION



This symbol indicates the need for separate waste collection of electronic and electrical equipment. Please do your part in protecting the environment and human health by reusing and recycling used electronic equipment whenever possible. Please do not dispose of such equipment as unsorted municipal waste. This product was put on the market after August 13, 2005.

Marquis Spas® is fully compliant with the European Union Council Directive 2002/95/EC (restriction of Hazardous Substances – RoHS).

Additionally, products are marked according to Annex IV of Council Directive 2002/96/EC (Waste Electrical and Electronic Equipment – WEEE) which addresses the handling of products at the end of their useful life.

OWNER'S MANUAL INDEX

IMPORTANT SAFETY INSTRUCTIONS
 All Spa Models 2
 Personal Safety..... 2

INSTALLATION INSTRUCTIONS
 Location..... 3
 Filter Cartridges..... 3
 Electrical Requirements..... 4

STARTING YOUR SPA 4-5

SPA CONTROL OPERATION
 All Models..... 5-6
 Audio System..... 7

EQUIPMENT DIAGRAMS
 660, 545, 530, 435, 425 and 322..... 8

SPA MODELS
 660..... 9
 545..... 10
 530..... 11
 435..... 12
 425..... 13
 322..... 14

TROUBLESHOOTING..... 15
 LCD Diagnostic Messages 15
 Maintenance Reminders..... 15

MAINTENANCE..... 15-16

WATER CARE
 Water Care Troubleshooting..... 17

EVERYDAY HOT TUBS WARRANTY..... 18
AUDIO SYSTEM LIMITED WARRANTY..... 19



WARNUNG: Bevor Erhaltenzugriff auf Terminale, müssen alle Versorgungskreisläufe abgeschaltet werden.

WARNING: Before obtaining access to terminals, all supply circuits must be disconnected.

SAFETY INSTRUCTIONS

The following instructions contain important safety information. We strongly encourage you to read and apply them.

IMPORTANT SAFETY INSTRUCTIONS

WHEN INSTALLING AND USING THIS ELECTRICAL EQUIPMENT, BASIC SAFETY PRECAUTIONS SHOULD ALWAYS BE FOLLOWED, INCLUDING THE FOLLOWING:

1. **READ AND FOLLOW ALL INSTRUCTIONS.**
2. **WARNING:** To reduce the risk of injury, do not permit children to use this product unless closely supervised at all times.
3. **DANGER: RISK OF CHILD DROWNING.** Extreme caution must be exercised to prevent unauthorized access by children. To avoid accidents, ensure that children cannot use the spa or hot tub unless they are supervised at all times.
4. **WARNING:** Disconnect all supply circuits before obtaining access to the terminal.
5. A ground/earth terminal is provided on the terminal block located on the outside of the control box. To reduce the risk of electric shock, connect this terminal to the grounding/earth terminal of your electrical service or supply panel with a continuous green/yellow, insulated copper wire. The wire must be equivalent in size to the circuit conductors supplying the equipment. In addition, a bonding terminal (pressure wire connector) is provided on the outside of the control box for bonding to local ground/earth points. To reduce the risk of electric shock, this connector should be bonded with a No. 8 AWG (8.42mm²) solid copper wire to any metal ladders, water pipes, or other metal within five feet (1.5m) of the spa to comply with local requirements.
6. Your spa uses ground fault circuit interrupters (GFCIs) or residual current devices (RCDs) in the electrical sub-panel. Before each use of the spa and with the unit operating, press the Test button on each breaker. The switch should click over to the "Trip" position. Wait thirty seconds and reset each RCD breaker by switching it completely off and then completely on. The switch should then stay on. If either of the interrupters does not perform in this manner, it is an indication of an electrical malfunction and the possibility of an electric shock. Disconnect the power until the fault has been identified and corrected.
7. Install the spa so proper drainage is provided for the compartment containing the electrical components.
8. **DANGER: RISK OF ELECTRIC SHOCK.** Do not permit any appliance, such as a light, radio, telephone, or television within 1.5m of the spa or hot tub.
9. **WARNING: TO REDUCE THE RISK OF INJURY.**
 - The water in the spa should never exceed 40° C. Water temperatures between 38° C and 40° C are considered safe for a healthy adult. Lower water temperatures are recommended for extended use (exceeding 10 minutes) and for young children.
 - Since excessive water temperatures have a high potential for causing fetal damage during the early months of pregnancy, pregnant or possibly pregnant women should limit spa water temperatures to 38° C.
 - Before entering a spa, the user should measure the water temperature with an accurate thermometer since the tolerance of temperature-regulating devices may vary as much as +/- -3° C.
 - The use of drugs, alcohol, or medication before or during spa use may lead to unconsciousness with the possibility of drowning.
 - Persons suffering from obesity or with a medical history of heart disease, low or high blood pressure, circulatory system problems or diabetes should consult a physician before using the spa.
 - Persons using medications should consult a physician before using a spa since some medication may induce drowsiness while other medication may affect heart rate, blood pressure, and circulation.
10. **DANGER: TO REDUCE THE RISK OF INJURY TO PERSONS.** Do not remove the suction fittings.
11. **DANGER: RISK OF INJURY.** Never operate a spa if the suction fitting(s) are broken or missing. Never replace a suction fitting with one rated less than the flow rate marked on the original suction fitting. The suction fittings in the spa are sized to match the specific water flow created by the pump. Should the need arise to replace the suction fittings or the pump, be sure that the flow rates are compatible.
12. **DANGER:** Children are especially sensitive to hot water. At no time should children have unsupervised access to the spa. Children must not be allowed to climb onto the spa cover. All Marquis Spas are equipped with a

locking safety cover. Always lock the child resistant locks after using the spa for your children's safety.

13. **CAUTION:** To reduce the number of airborne bacteria in an enclosed spa area, proper ventilation must be provided.
14. **WARNING:** The design and construction of this spa are in accordance with all applicable regulations. Modifying or adding spa components may affect proper spa functioning, and may void the compliance markings.
15. **SAVE THESE INSTRUCTIONS.**

PERSONAL SAFETY

Prolonged immersion in hot water can result in **HYPERTHERMIA**, a dangerous condition which occurs when the internal temperature of the body reaches a level above normal (37°C). The symptoms of hyperthermia include dizziness, fainting, drowsiness, lethargy, and a body temperature above 37°C. The physical effects of hyperthermia include unawareness of impending hazard, failure to perceive heat, failure to recognize the need to exit the spa, physical inability to exit the spa, fetal damage in pregnant women, and unconsciousness resulting in a danger of drowning.

WARNING: The use of alcohol, drugs, or medication can greatly increase the risk of fatal hyperthermia in hot tubs and spas.

Persons taking medications which induce drowsiness such as tranquilizers, antihistamines, or anticoagulants should not use the spa. Pregnant women and persons with a medical history of heart disease, diabetes, or high blood pressure should consult a physician before using the spa.

PERSONAL SAFETY DOS:

- Be sure your spa is connected to the power supply correctly – use a licensed contractor.
- Disconnect the spa from the power supply before draining the spa or servicing the electrical components.
- Test the RCD monthly.
- Test the water temperature with your hand before entering the spa to be sure that it's a comfortable temperature.
- Do not use the spa if water temperature is outside of set temperature.
- Remember that wet surfaces can be very slippery. Take care when entering and exiting the spa.
- Use the safety cover when the spa is not in use, whether it is empty or full of water.
- Keep the water clean and sanitized with correct chemical care.
- Turn on the jets when adding ANY spa water chemicals.
- After running the pump for three consecutive 15 minute periods (if so desired), allow for a 30 minute cool-down period.
- Clean the filter cartridge(s) monthly to remove debris and mineral buildup which may affect the performance of the hydrotherapy jets, limit the flow, or trip the high limit thermostat which will turn off the entire spa.

PERSONAL SAFETY DON'TS:

- Don't use the spa with the equipment compartment door removed.
- Don't use the spa for long periods of time at water temperatures in excess of 40°C.
- Don't allow the jet pump(s) to operate for an extended period of time with the cover in place. Extended pump operation will cause a slow heat buildup due to water friction. The spa equipment controls are equipped with a built-in safety timer that will automatically shut off the jet pump(s) after 15 minutes of continuous operation should it have been left on inadvertently.
- Don't operate the spa at any time with the filter cartridge(s) removed.
- Don't lift or drag the cover by using the tie-down straps or cover skirting; always lift and carry by using the external handles.
- Don't store chemicals in the spa's equipment compartment.

INSTALLATION INSTRUCTIONS

LOCATION

For your portable spa to function properly and safely, it must be located on a hard, flat, level surface. Inground spas require special installation techniques and should be planned in conjunction with your authorized Marquis Spas® dealer. Improper installation can result in structural damage to the spa and the voiding of your spa warranty. Items to discuss with your dealer include: local construction codes, electrical service requirements, serviceability of equipment, existing underground obstructions such as gas, water, and telephone lines, safety measures such as fences and locks, and visibility of the spa installation from the home, street, and neighbours.

- Do not shim your spa. If your pad is not level you must pour a top cap: contact a professional.
- Allow for sufficient water drainage around the spa to help preserve the equipment and support structure. This includes indoor installations.
- A filled spa can weigh up to 2268 Kg and the location must support the weight of the filled spa.
- Locate the equipment compartment where it will be accessible. Your spa MUST be installed to permit access for servicing the equipment above and/or below any decks or floors. Access is essential and must allow adequate room for service. To facilitate repairs, Marquis Corp. or its agent may require access to spa equipment. It is your responsibility to provide unencumbered access. See spa diagrams for location of power supply.
- Leave access to the circuit breakers in the sub panel.
- Be sure the spa is level and in the final position BEFORE filling with water. Check for power cords, tools, and hoses that may be caught underneath the spa.
- Do not apply power to the spa before it is completely filled with water. Damage to the pumps, heater and sensors may result.
- **IMPORTANT: DO NOT LET AN EMPTY SPA REMAIN EXPOSED TO DIRECT SUNLIGHT.** Spa surface temperatures can reach in excess of 82°C if left exposed to the sun. Significant damage can occur if this is allowed to happen, including warping and blistering of the surface and components. Damage that occurs as a result of this exposure is not covered under the warranty.
- **CAUTION:** Never try to move a spa that has not been fully drained. To do so could result in damage to the spa and physical injury to the mover.
- Cracks in the spa surface, exterior siding or DuraBase due to improper transport or support of the spa are not covered under the warranty.

OUTDOOR AND PATIO INSTALLATION

To install the spa outdoors, we recommend a reinforced concrete pad at least 10 cm thick. The reinforcing material should be grounded per electrical codes.

If you place the spa on the ground, even temporarily, place the spa empty of water on concrete pavers under the entire bottom of the spa. The concrete pavers should be at least 5 cm thick and level across the entire surface. The spa will inevitably settle and become out of level on this surface, thus it is important to get the spa onto a solid foundation as soon as possible.

INSTRUCTIONS FOR PREFABRICATED SPA PADS

If you are using a prefabricated spa pad for a foundation, please use the following guidelines:

1. Designate the area where the spa is to be installed. Please make sure the ground is flat and level.
2. Using 2"x 6" weather resistant lumber and 3" outdoor deck screws, build a frame large enough for the prefabricated spa pad to fit inside with minimum 1" clearance on all sides.
3. Install the frame in the area that has been leveled.
4. Using pea gravel, please fill the frame to the top.
5. Lay a straight piece of lumber across the frame and level any high spots in the gravel by pushing the straight lumber across the frame. Fill in any low areas with more gravel and re-level using the straight piece of lumber.
6. Compact the gravel to make the surface is hard and flat. You may need to add more gravel to bring the level back up to the top of the frame. If so, please re-level and re-compact until you have a hard, flat level surface that is even with the top of the frame.
7. Place the prefabricated spa pad on top of the gravel. Please be careful not to disturb the hard, flat, level surface.

8. Please make sure no portion of the spa pad is sitting outside or on top of the framing.
9. Place the spa on top of the pad and fill the spa with water.

DECK INSTALLATION

Be sure the deck can support the weight of your filled spa by checking the deck's maximum load capacity. Consult a qualified building contractor or structural engineer. Minimum requirement is 45.36 Kgs. per 9.3 cm. Modular spa foundations may not be used to support the spa. Use of modular foundations without proper preparation and installation can cause your spa to settle over time and could cause the spa to crack. Cracks caused by lack of support are not covered by warranty.

If you are using a prefabricated spa pad for a foundation, please follow guidelines:

1. Designate spa installation area. Make sure the ground is flat and level.
2. Using 2"x 6" weather resistant lumber and 3" outdoor deck screws, build a frame large enough for the prefabricated spa pad to fit inside with minimum 1" clearance on all sides.
3. Install the frame in the area that has been leveled.
4. Using crushed gravel, fill the frame to the top.
5. Lay a straight piece of lumber across the frame and level any high or low spots. Re-level using the straight piece of lumber.
6. Compact gravel to make surface hard, flat and even with the top of the frame.
7. Place prefabricated spa pad on top of the gravel. Don't disturb level surface.
8. Make sure no portion of the spa pad is sitting outside or on top of the framing.
9. Place the spa on top of the pad and fill the spa with water.

INDOOR INSTALLATION

There are special requirements if you place your spa indoors. Flooring material must provide adequate traction when wet. Proper drainage is essential to prevent water pooling. To avoid increased humidity, you need to provide proper ventilation to the area. The addition of a ventilation system is recommended.

SHUT-OFF VALVES

Your spa is equipped with shut-off valves (see EQUIPMENT DIAGRAM) that shut off the water flow to the equipment system for authorized Marquis Spas® dealer service. At times, a new spa or one that has recently been serviced may have the shut-off valves partially closed which can restrict the water flow and hinder jet performance. Be sure the valves are fully open.

FREEZE PROTECTION

When a freeze condition is detected (which occurs when the temperature in the heater housing drops to 13°C), the jet pump(s) is automatically activated. In areas with extremely cold winter conditions, your spa should be fine as long as it is left running at normal operating temperatures. If you plan to turn the spa off, follow the instructions in this manual (see SUSPENDED USE OR WINTERIZING YOUR SPA).

OVERHEATING

In the case of extended hot weather, the spa water temperature may reach and maintain 40°C to 41°C or higher. This is due to the ambient temperature and the full insulation in the spa cabinet. You may have the option of shortening the pump-run time. (See SPA CONTROL OPERATION for available options.)

FILTER CARTRIDGE(S)

Your portable spa features one or two Vortex filters.

Filter cartridges and filter lids are warranted to be free of defect at time of delivery and do not qualify for labor coverage under the warranty. These parts can be purchased or exchanged at your authorized Marquis Spas® dealer.

NOTE: It is very important that the components of these filtration systems be installed properly in the proper part of the spa.

STARTING YOUR SPA

START-UP PROCEDURE

Your spa is equipped with solid-state Comfort Controls specific to your spa model. (See SPA CONTROL OPERATION for your specific spa model.)

To start your spa, you need a spa water test kit or test strip and an underwater thermometer. It is important to follow each of these steps when starting your spa. Once you have completed the following steps, refer to the instructions in your start-up kit for proper start-up water maintenance, or see MARQUIS SPA CARE.

NOTE: Your spa has been filled and test-run at the factory. The first time your spa is filled with water, some discoloration from residual test water may appear. This will disappear when the spa is completely filled and the filtration system is functioning.

WARNING: Spa must be completely filled with water before turning on power.

Test the water for the proper chemical balance and adjust as necessary. Marquis SpaCare™ products are recommended. (See WATER TREATMENT.) **PROPER CHEMICAL BALANCE IS IMPORTANT** for your safety and the longevity of your spa.

In the case of relocating your spa, it is imperative to follow the instructions in the owner's manual. These instructions must remain with the spa. Damage caused by relocating spa is not covered under warranty.

THERAPY PUMP(S)

Start-up procedure for all models

1. Place spa on a hard, flat, level surface. Make sure the power supply is off.
2. Make sure the suction guard(s) in the footwell are in place and undamaged.
3. Open the equipment door. Tighten all disconnects and open all shut-off valves.

NOTE: Keep the drain valve closed at all times except when draining the spa (do not rely on the cap to stop the flow of water). Not doing so could result in damage to the drain valve due to freezing water.

4. Install filter cartridges. (See INSTALLATION INSTRUCTIONS, Filter Cartridges.)
5. Fill the spa with water to two-thirds of the way up the Vortex skimmer openings.
The use of a Fill Filter is recommended, especially in areas with high mineral content in the water.
6. Turn the power on.
7. Your spa is now displaying "LINK" in the LCD window on the control panel.
8. Press the TEMP button to start the spa and LINK will disappear.
9. The spa is now displaying "RUN PMPS PURG AIR" in the LCD window, press the JET 1 button to run the pump and purge the air from the plumbing.
10. After a few minutes the system will go into standard operations.
11. The temperature factory default is 37°C; you can change the temperature by pressing the TEMP button. The maximum set point is 40°C.

ENERGY COVER

When the spa is not in use, the cover should be kept on the spa to retain the water's heat and to keep out dirt, leaves, etc. Your Marquis spa must be equipped with a Marquis energy cover to receive full acrylic shell warranty. Other covers may not provide adequate protection. Fading and staining of the spa cover and broken foam cores are not covered under warranty for any reason. Spa covers do not qualify for labor coverage under warranty. Purchase or exchange parts under warranty at authorized Marquis dealer.

For your safety and convenience, the cover is equipped with adjustable straps, safety locks, and handles. Use the exterior handles to remove and replace your cover. Never attempt to open or remove the cover by grasping or pulling on the cover skirting or cover lock straps as the skirting will tear.

Marquis suggests you use the safety locks to help keep out unintended users and prevent covers from being blown off in windy conditions. The cover and retractable cover system are not recommended for use in wind conditions

reaching above 40 km/h. If your spa is located in an area susceptible to high winds, additional cover lock straps may be necessary to minimize cover damage.

Open the spa cover:

1. Unfasten all cover lock straps.
2. Place one hand under the cover skirting, between the spa and cover, to break the cover's vacuum seal. Do not use cover handles to break vacuum seal.
3. Fold the front half of the cover over onto the back half.

NOTE: Unlock and release all cover locks before attempting to open cover. Damage caused by attempting to open the cover while locked or by wind is not covered under warranty. Do not walk, stand, climb, or sit on the vinyl cover or retractable cover system. Do not use hard, sharp, or metal objects, such as a windshield scraper, to remove ice. Such objects can cut, mar, or puncture the cover's vinyl surface.

Close the spa cover:

1. Place one hand on the upper corner of the cover and gently push forward in the direction of the spa. The cover will rotate forward to cover half of the spa.
2. Unfold the cover by lifting the handle located on the top (front) half of the cover. Allow the unfolded half to fall down onto the spa.
3. Secure the cover lock straps to the spa and lock them.

NOTE: When opening a cover with a cover removal mechanism, use one of the manufacturer's recommended methods. Do not attempt to open the cover in any other way. Damage caused by improper opening or closing of the cover is not covered under the warranty.

Fading, staining, torn stitching of the spa cover and broken foam cores are not covered under the warranty for any reason. Spa covers do not qualify for labor coverage under the warranty. These parts can be purchased or exchanged under warranty at your authorized Marquis Spas® dealer.

SPA CONTROL OPERATION

All models



START-UP

- At initial power up, the LCD display on the panel will flash "LINK". Press any on the buttons on the control panel to link the panel to the control box and remove the "LINK" message from the display.
- "RUN PMPS PURG AIR -- -- --" will be displayed on the panel. This is an opportunity to run the pumps and purge any air from the system and associated plumbing lines. This period will last 4-5 minutes or can be exited by pressing the Temp +/- button.
- "SET TIME" will be displayed on the panel window. To enter the time, press the listed buttons in the following sequence. Button presses must occur within 3-5 seconds of each other.
 - Temp +/-
 - Light: Press until you see "TIME" displayed in the LCD display on the panel.
 - Temp +/- To display clock
 - Temp +/- To adjust hour (note the AM – PM indicator in the display)
 - Light: To move to minutes
 - Temp +/- To adjust minutes
 - Light: To hold and exit or wait 10 seconds for automatic exiting

Note: In the event of a power interruption/loss, the start-up sequence will need to be repeated.

OPERATING THE SPA

Jets 1

Press Jets 1 button to turn on pump one to low speed. Pressing a second time will turn the pump on to high speed. Pressing a third time will turn the pump off. The high speed of pump 1 will run for 15 minutes and then switch to low speed. Once on low speed, the pump will run for 15 minutes and then shut off. The high and low speed operation will stop after 15 minutes of use. If the system is in a filter cycle or calling for heat, low speed will continue to run. To restart the pump, press the Jets 1 button. The yellow LED indicator under the LCD display will illuminate anytime the pump is running.

Jets 2 (Two Pump Models Only)

Press Jets 2 button to turn on pump two high speed. Pressing a second time will turn the pump off. The high speed of pump 2 will run for 15 minutes and then turn off. To restart the pump, press the Jets 2 button.

Adjusting temperature (factory default 38° C)

To adjust the temperature of the water, press the Temp +/- button. The display always shows actual water temperature. The first press of the button will display the set temperature and begin to flash. Continue to press or hold the Temp +/- to reach the desired set temperature. Once the display stops blinking the new temperature setting will be set. The factory default setting is 38° C. The minimum temperature that can be set is 27° C and the maximum temperature that can be set is 40° C. If a lower set temperature is desired, see User Programming section – Dual Temperature Range.

Soak

Pressing the Soak button will turn off all pump operation. This is a useful feature when soaking in the hot water with no jets running is desired. The Soak feature will last 60 minutes and then resume normal operation. Pressing any jet button will override the soak feature and turn on the pumps or you can simply press the Soak button to exit the mode. Turning the LED lights on and off will not affect the quite soak mode. The yellow LED indicator light under the LCD display will illuminate anytime this feature is engaged.

Note: If the system is heating it will take a few moments for the Quiet Soak feature to engage.

Timer

Press the Timer button to start the timer. The display will start at E00 and begin timing how long you have been in the spa or using a certain feature. "E" is for elapsed and the two trailing characters track time in one minute intervals. The display will alternate with the current water temperature every 10 seconds. The timer will continue to run up to 60 minutes. To turn off, press the Timer button one time. The yellow LED indicator below the LCD display will illuminate anytime this feature is running.

Light

Press the Light button to turn the interior spa lights on and off. Pressing the button repeatedly (within 2-3 seconds of each press) will allow for color scrolling of the LED lights. If left on the lights will run for 60 minutes and then turn off automatically.

panel.

USER PROGRAMMING

The following features allow for additional control and setting of the on-board electronics. In most cases the factory default settings are adequate for normal use and operation. To access any of the following features press Temp +/- and then Light: then scroll through the features by continuing to press the Light button.

You exit the programming mode at any time by continuing to press the Light button until you arrive back at the temperature display or by simply pausing for 10 to 20 seconds.

Dual Temperature Range (Factory default "Range ▲" recommended)

The system supports the choice of two temperature ranges for controlling heat. This feature can be useful if you plan on being gone for an extended period of time or anticipate infrequent use of the spa. The temperature range indicator is located on the bottom half of the LCD display and will be shown as "Range ▲" for high range or "Range ▼" for low range. The default temperature range, or high range, is 27° C to 40° C. The optional low range is 13° C to 27° C. To change the range setting, press the listed buttons in the following sequence. Button presses must occur within 3-5 seconds of each other.

- Temp +/-
- Light – until "TEMP" is displayed in the LCD window
- Temp +/- to change range setting to ▲ for high or ▼ for low.
- Light – to select and exit. To return the display to the original position, follow the same sequence.

Mode (Ready mode is factory default - recommended)

This feature can be used for periods of when you are planning on being gone for an extended amount of time and don't want the spa running more regularly. Putting the unit in "Ready" mode will ensure the spa is at full temperature and ready for use at any time. Putting the unit in "Rest" mode will only allow the spa to heat during a scheduled filtration cycle. To access and change the mode, press the listed buttons in the following sequence. Button presses must occur within 3-5 seconds of each other.

1. Temp +/-
2. Light: Press until "MODE" appears in the LCD display
3. Temp +/- To toggle between ready and rest options. The options will appear in the bottom of the LCD display in small print
4. Light: To select and exit

Time

Use this function to reset or change the internal time clock. Note that this feature is not an actual clock that will display on the panel. The clock feature is used as a basis for running filter cycles during the correct time of the day. To set or adjust the clock, press the listed buttons in the following sequence. Button presses must occur within 3-5 seconds of each other.

1. Temp +/-
2. Light: Press until you see "TIME" displayed in the LCD display on the panel.
3. Temp +/- To display clock
4. Temp +/- To adjust hour (note the AM – PM indicator in the display)
5. Light: To move to minutes
6. Temp +/- To adjust minutes
7. Light: To hold and exit

"FLIP" (Invert Display)

Your spa will come preset from the factory with the display viewable from inside the spa (recommended). The system will allow the LCD display on the panel to invert or "FLIP" to allow reading the display from outside of the spa if desired. To "FLIP" the display, press the listed buttons in the following sequence. Button presses must occur within 3-5 seconds of each other.

1. Temp +/-
2. Light: Until the word "FLIP" appears in the LCD
3. Temp +/- to invert the display
4. Light: To select and exit

To return the display to the original position, follow the same sequence

Temperature Lock or Panel Lock (Unlocked is the factory default - Recommended)

The electronic controls can be locked in two levels, temperature lock and panel lock. Temperature lock will lock the temperature control/button only. Panel lock will lock all of the controls and buttons on the panel. These choices can be a useful feature to keep others from accidentally changing the settings or operating functions available through the control panel. To engage temperature lock, press the listed buttons in the following sequence. Button presses must occur within 3-5 seconds of each other.

1. Temp +/-
 2. Light: Until you see the word "LOCK" in the LCD display
 3. Temp +/- Which will display "TEMP" on the first press. Continue pressing to change between on and off
 4. Light: To select and exit
- To engage panel lock, press the listed buttons in the following sequence. Button presses must occur within 3-5 seconds of each other.

1. Temp +/-
2. Light: Press until you see the word "LOCK" in the LCD display
3. Temp +/- to enter the menu, "TEMP" will be displayed
4. Light: To display "PANL" in LCD display
5. Temp +/- to display on/off choice
6. Light: To select and exit

To unlock either temperature or panel lock feature, use the following directions.

1. Press and hold down the Temp +/- button
2. While holding down the Temp +/- button, press the Light button two (2) times
3. The LCD display will read "UNLK" restoring the panel buttons to full operation.

Hold

This is a feature that can be used while servicing your spa such as cleaning the spa shell or the filter. The Soak button on the panel can also perform the same function. If you choose to use the Hold mode, press the listed buttons in the following sequence. Button presses must occur within 3-5 seconds of each other.

1. Temp +/-
2. Light: Press until you see "HOLD" in the LCD display.
3. Temp +/- to engage the hold mode. The panel will scroll "HOLD – ING – FOR – 0:60" and continue to count down. LCD display will read "DONE"
4. Light: To stop and exit the hold mode at any time. LCD display will read "DONE"

Filtration Cycles (Factory default is 2 hours one time per day)

The electronic controls will allow for additional control for up to two independent filtration cycles to be set. This can be useful if your usage patterns vary from light to heavy and/or you need more or less filtration time to aid in maintaining clean water. To adjust the filtration times, press the listed buttons in the following sequence. Button presses must occur within 3-5 seconds of each other.

1. Temp +/-
2. Light: Press until you see the word "FLTR" with a small "1" in the LCD screen
3. Temp +/- Which will change display to "BEGN". This will be when the cycle starts during the day or night.
4. Temp +/- To show time. Continue to press to adjust the hour in one hour intervals
5. Light: To change the display to minutes
6. Temp +/- To change minutes in increments of 15 intervals
7. Light: To set and move to next screen which will be "RUN HRS". This is how long the cycle will run.
8. Temp +/- To choose the number of hours you want the spa to filter in one hour intervals
9. Light: To change the display to minutes
10. Temp +/- To choose the number of minutes you want the spa to filter in 15 minute intervals.
11. Light: To set and show end time. This will be displayed in the LCD window as "F 1 – ENDS – TIME"
12. Light: To move on to filter cycle 2 which will be displayed in the LCD window as "FLTR" with a small "2".
13. Temp +/- to choose on or off. If on is chosen, repeat steps 3 through 11 to set filter cycle 2.
14. Light: To exit.

Light Timer (Factory default is off – Recommended)

The LED spa lights can be set to come on and go off at specified times during the day or night. To set the light timer, press the listed buttons in the following sequence. Button presses must occur within 3-5 seconds of each other.

1. Temp +/-
2. Light: Press until you see the word "LITE TIMR" in the LCD display
3. Temp +/- To toggle between on and off
4. Light: To set and change the display to "BEGN". This is when the timer will start.
5. Temp +/- To display hour window and change hour in increments of 1 hour intervals
6. Light: To set and move to next screen which will be minutes.
7. Temp +/- To choose the number of minutes to run in 15 minute intervals.
8. Light: To set and display "RUN HRS" This is how long the timer will run.

9. Temp +/- To display hour window and change hours to run in 1 hour increments.
10. Light: To set and show minutes
11. Temp +/- to choose minutes of operation in 15 minutes intervals.
12. Light: To set, LCD display will show "TIMR – ENDS – XX:XX" XX:XX being the time the light will turn off.
13. Temp +/- to exit the mode

Preferences

Fahrenheit or Celsius to be displayed on the LCD panel (F is the default)

1. Temp +/-
2. Light: Press until you see "PREF" in the LCD screen
3. Temp +/- Which will show F/C in the LCD display
4. Temp +/- To toggle between F (Fahrenheit) or C (Celsius)
5. Light: To set and exit

24 hour or 12 hour clock (12 hour is the default)

1. Temp +/-
2. Light: Press until you see "PREF" in the LCD screen
3. Temp +/- Which will show "24-12" in the LCD display
4. Temp +/- To toggle between 24HR and 12HR
5. Light: To set and exit

Clean-Up Cycle (0 to 4 hour choice – factory default 1 hour)

1. Temp +/-
2. Light: Press until you see "PREF" in the LCD screen
3. Temp +/- Which will show "CLN-- UP" in the LCD display
4. Temp +/- To toggle between 0 (Off) and up to 4 hours in 30 minute intervals
5. Light: To set and exit

Utilities

The information listed in the Utilities section is system information only. These are features normally used for service technicians and should not need to be accessed by the consumer.

TEMPO AUDIO SYSTEMS

Tempo I Audio System

The audio system is easy to operate with logical push button controls and function keys. Please refer to the manufacturer's owner's manual for features, operation, and troubleshooting.

NOTE: Avoid water splashing on the stereo face. Never insert a disk or operate the stereo with wet hands. Moisture can damage internal components. Water intrusion into stereo is not covered under warranty. See manufacturer's owner's manual for coverage information. Consult your Limited Warranty for more information about coverage.

Speakers

Gently push the top of the self-rising speakers to raise them. Hold the speaker top, avoiding the speaker screens, and gradually rotate the speakers as desired. To lower the speakers gently push the speaker top until it is completely closed. Make sure speakers are in the down position before closing the spa cover. Speaker lift mechanism is manufacturer-warranted against failure to lift due to manufacturing defects only. Closing the spa cover with speakers in the up position or forcing the speaker down too rapidly can result in damage.

- **CAUTION** - Risk of Electric Shock. Do not leave compartment door open.
- **CAUTION** - Risk of Electric Shock. Replace components only with identical components.
- Do not operate the audio controls while inside the spa.
- **WARNING** – Prevent Electrocution. Do not connect any auxiliary components (for example, cable, additional speakers, headphones, additional audio/video components, etc.) to the system, except as provided by the following: The 3.5 mm auxiliary jack is designed for input only from devices such as an MP3 player operating at 4.5 V or less.

- These units are not provided with an outdoor antennae; it should be installed in accordance with Article 810 of the National Electrical Code, ANSI/NFPA 70.
- Do not service this product yourself as opening or removing covers may expose you to dangerous voltage or other risk of injury. Refer all servicing to qualified service personnel.
- If the power supply connections or power supply cord(s) are damaged; if water is entering the audio compartment or any electrical equipment compartment area; if the protective shields or barriers are showing signs of deterioration; or if there are signs of other potential damage to the unit, turn off the unit and refer servicing to a qualified service personnel.
- This unit should be subjected to periodic routine maintenance (for example, once every three months) to make sure that the unit is operating properly.

Audio Expansion Port

The built-in audio expansion port allows you to connect optional accessories. Use the supplied 3.5 cm cord to attach MP3 player. **NOTE:** The 3.5 cm auxiliary jack is designed for input only from devices such as an MP3 player operating at 4.5V or less.

Tempo III Audio System

This system will support a wide range of personal audio players with 3.5mm jacks operating at 4.5V or less. Typically this would be the headphone jack on the device. To use, pull on the recessed handle of the device drawer that is located on the door of the spa. Once fully extended, open the lid of the drawer exposing the supplied 3.5mm cable and plug in the personal audio player. Song selection, volume, and tone are controlled by the personal audio device. Once the unit is playing, stow the personal audio device in the drawer, close the lid and push the drawer back in place. This will ensure the personal audio device is protected during use.

EQUIPMENT DIAGRAMS

MODEL 660

#	Component	Quantity
1	Control box and heater	1
2	Two-speed pump	1
3	One-speed pump	1
4	Slice valves	2
5	Pump unions	4
6	Pump plugs	2
7	Motor mounts	8
8	Hose bib drain	1
9	Light bulb	1
10	Ozone fitting	1
11	Check valve	1
12	Ozonator (optional)	1
13	Stereo power supply (optional)	1
14	Stereo MP3 plug (optional)	1
15	Stereo head unit (optional)	1

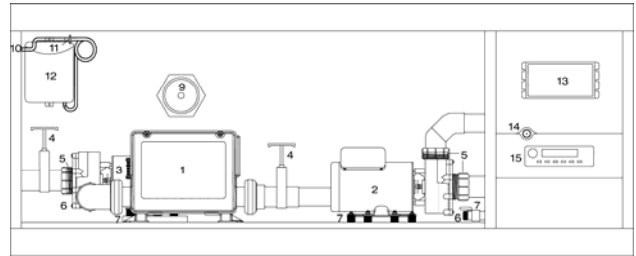

660 EQUIPMENT

MODEL 545 & 530

#	Component	Quantity
1	Control box and heater	1
2	Two-speed pump	1
3	One-speed pump	1
4	Slice valves	2
5	Pump unions	4
6	Pump plugs	2
7	Motor mounts	8
8	Hose bib drain	1
9	Light bulb	1
10	Ozone fitting	1
11	Check valve	1
12	Ozonator (optional)	1
13	Stereo power supply (optional)	1
14	Stereo MP3 plug (optional)	1
15	Stereo head unit (optional)	1

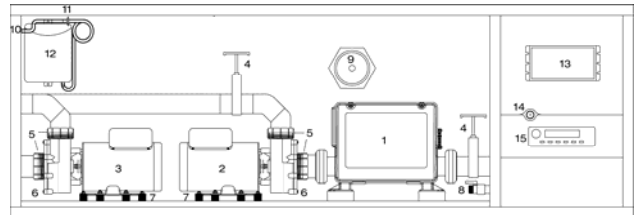

545 EQUIPMENT

MODEL 435

#	Component	Quantity
1	Control box and heater	1
2	Two-speed pump	1
4	Slice valves	2
5	Pump unions	2
6	Pump plug	1
7	Motor mounts	4
8	Hose bib drain	1
9	Light bulb	1
10	Ozonator fitting	1
11	Check valve	1
12	Ozonator (optional)	1
13	Stereo power supply (optional)	1
14	Stereo MP3 plug (optional)	1
15	Stereo head unit (optional)	1

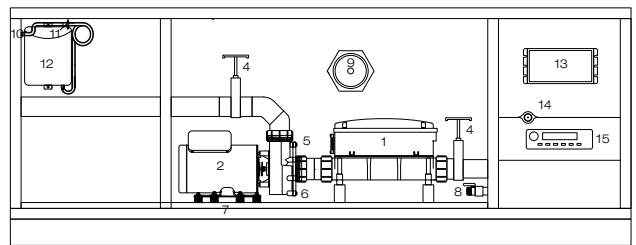

530 EQUIPMENT

MODEL 322

#	Component	Quantity
1	Control box and heater	1
2	Two-speed pump	1
3	Slice valves	2
5	Pump unions	2
6	Pump plug	1
7	Motor mounts	4
8	Light bulb	1
9	Hose bib drain	1
10	Ozonator fitting	1
11	Ozonator (optional)	1
12	Check valve	1
13	Stereo power supply (optional)	1
14	Stereo MP3 plug (optional)	1
15	Stereo head unit (optional)	1

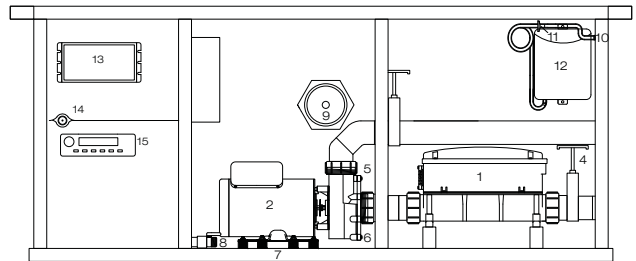

435 & 425 EQUIPMENT

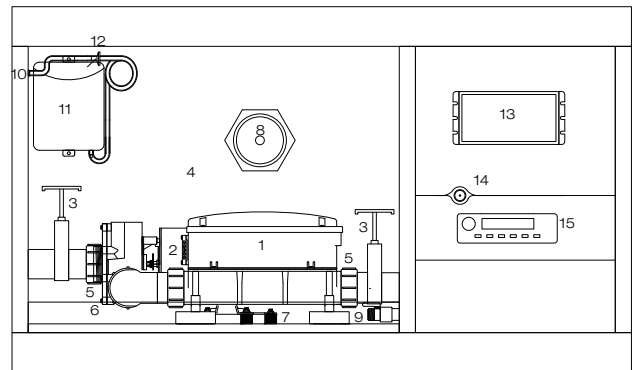

322 EQUIPMENT

660™

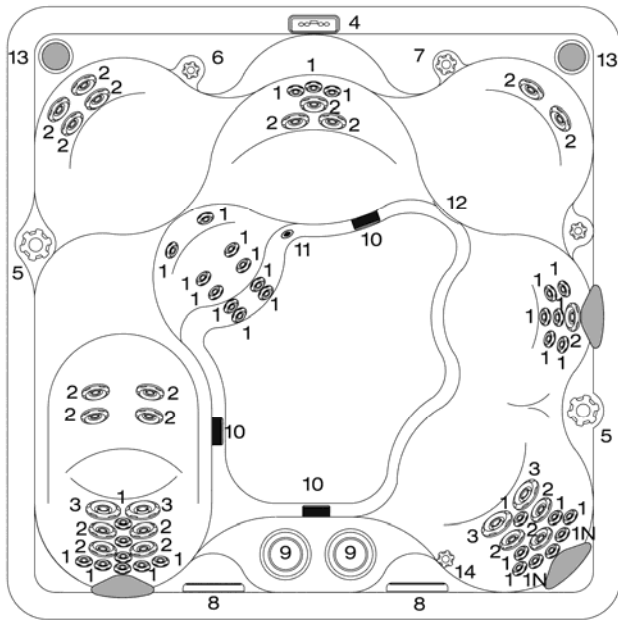

#	Component Identification	Quantity
1	200 Series Jets	33
1N	200 Series Neck Jets	2
2	300 Series Jets	21
3	400 Series Jets	4
4	Control Panel	1
5	Jet Selectors	2
6	Air Control	1
7	Waterfall Valve	2
8	Waterfall features	2
9	Filter Canisters	2
10	Suction Fittings	3
11	Floor Drain	1
12	Light	1
13	Stereo Speakers (option)	2
14	Neck Jet Valve	1

Physical Specifications	Size
Dimensions/mm	2286 X 2286
Height/mm	864
Seating Capacity/Positions	6/6
Weight Dry/Kgs.	354
Weight Full/Kgs.	1829
Water Capacity/Litres	1476
Total Therapy Jets	60

660 ZONES

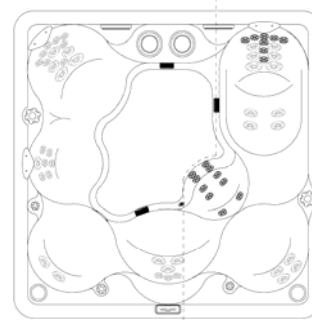

JETS 2 ZONE 2

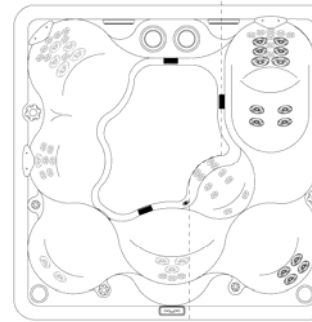

JETS 2 ZONE 1

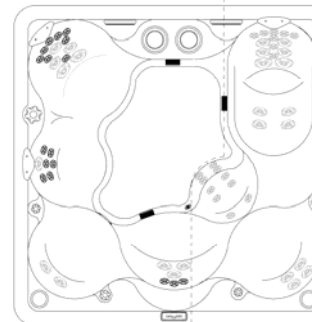

JETS 1 ZONE 2

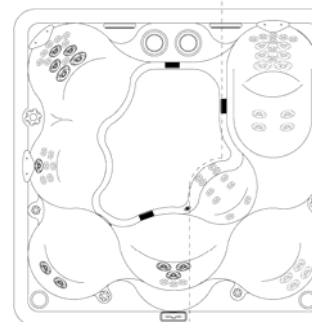

JETS 1 ZONE 1

545™

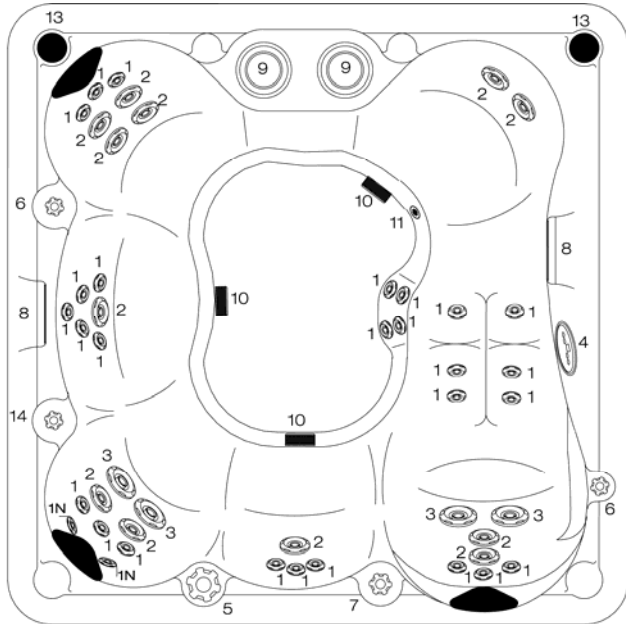

#	Component Identification	Quantity
1	200 Series Jets	27
1N	200 Series Neck Jets	2
2	300 Series Jets	12
3	400 Series Jets	4
4	Control Panel	1
5	Jet Selector	1
6	Air Controls	2
7	Waterfall Valve	1
8	Waterfall features	2
9	Filter Canisters	2
10	Suction Fittings	3
11	Floor Drain	1
12	Light	1
13	Stereo Speakers (option)	2
14	Neck Jet Valve	1

Physical Specifications	Size
Dimensions/mm	2134 X 2134
Height/mm	864
Seating Capacity/Positions	4/5
Weight Dry/Kgs.	336
Weight Full/Kgs.	1660
Water Capacity/Litres	1325
Total Therapy Jets	45

545 ZONES

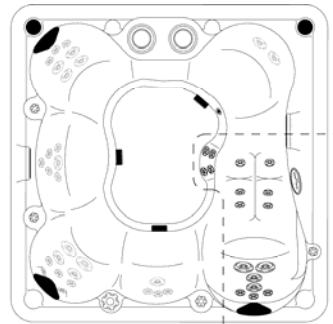

JETS 2 ZONE 2

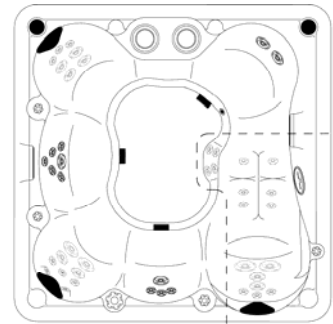

JETS 1 ZONE 2

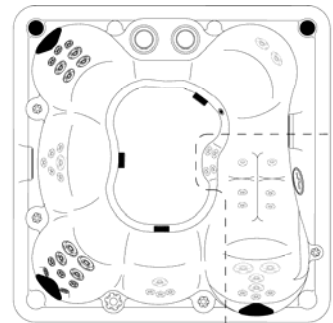

JETS 1 ZONE 1

530™

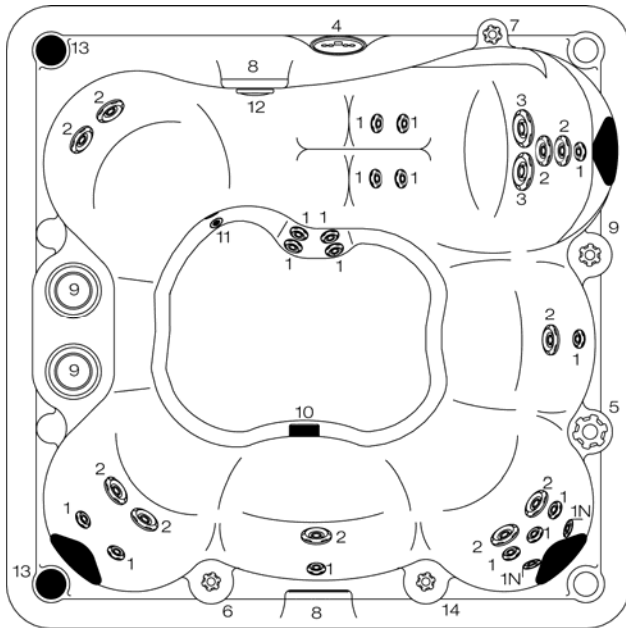

#	Component Identification	Quantity
1	200 Series Jets	16
1N	200 Series Neck Jets	2
2	300 Series Jets	10
3	400 Series Jets	2
4	Control Panel	1
5	Jet Selector	1
6	Air Controls	2
7	Waterfall Valve	1
8	Waterfall features	2
9	Filter Canisters	2
10	Suction Fitting	1
11	Floor Drain	1
12	Light	1
13	Stereo Speakers (option)	2
14	Neck Jet Valve	1

Physical Specifications	Size
Dimensions/mm	2134 X 2134
Height/mm	864
Seating Capacity/Positions	6/6
Weight Dry/Kgs.	336
Weight Full/Kgs.	1660
Water Capacity/Litres	1325
Total Therapy Jets	30

530 ZONES

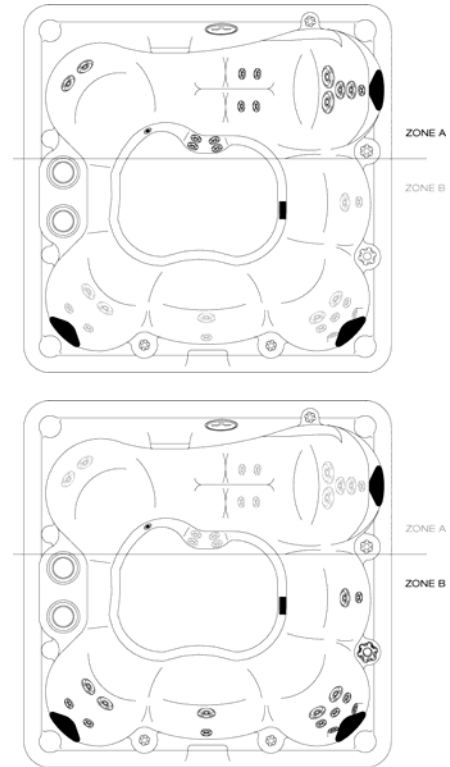

435™

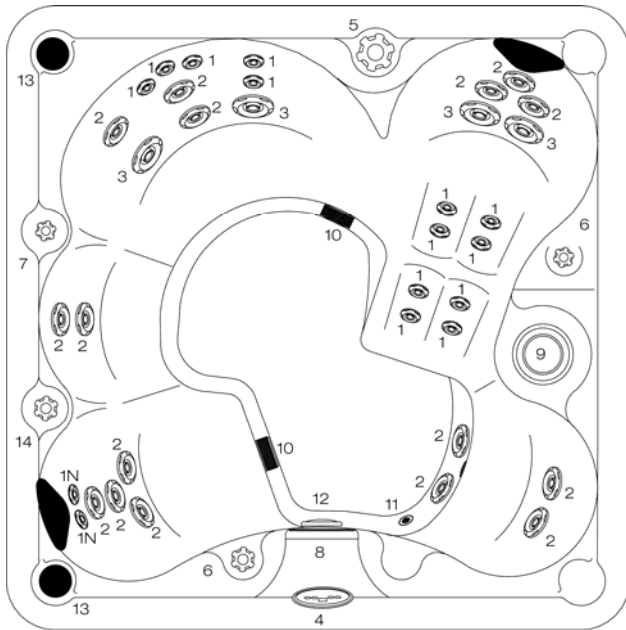

#	Component Identification	Qty.
1	200 Series Jets	13
1N	200 Series Neck Jets	2
2	300 Series Jets	16
3	400 Series Jets	4
4	Control Panel	1
5	Jet Selector	1
6	Air Control	2
7	Waterfall Valve	1
8	Waterfall Feature	1
9	Filter Canister	1
10	Suction Fittings	2
11	Floor Drain	1
12	Light	1
13	Stereo Speakers (option)	2

Physical Specifications	Size
Dimensions/mm	1956 X 1956
Height/mm	864
Seating Capacity/Positions	4/5
Weight Dry/Kgs.	227
Weight Full/Kgs.	1399
Water Capacity/Litres	1173
Total Therapy Jets	35

435 ZONES

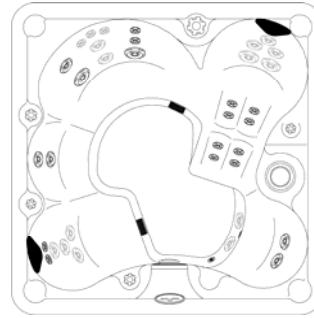

ZONE 2

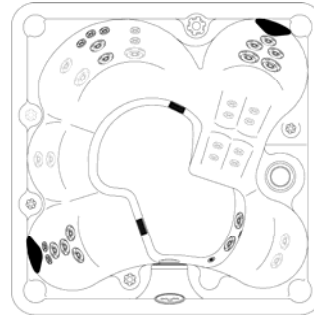

ZONE 1

425™

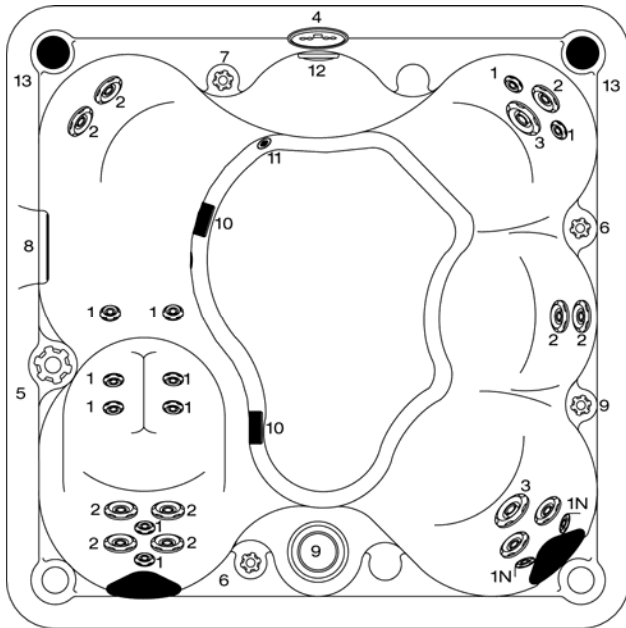

#	Component Identification	Qty.
1	200 Series Jets	10
1N	200 Series Neck Jets	2
2	300 Series Jets	11
3	400 Series Jets	2
4	Control Panel	1
5	Jet Selector	1
6	Air Control	2
7	Waterfall Valve	1
8	Waterfall Feature	1
9	Filter Canister	1
10	Suction Fittings	2
11	Floor Drain	1
12	Light	1
13	Stereo Speakers (option)	2

Physical Specifications	Size
Dimensions/mm	1956 X 1956
Height/mm	864
Seating Capacity/Positions	4/5
Weight Dry/Kgs.	215
Weight Full/Kgs.	1350
Water Capacity/Litres	1136
Total Therapy Jets	25

425 ZONES

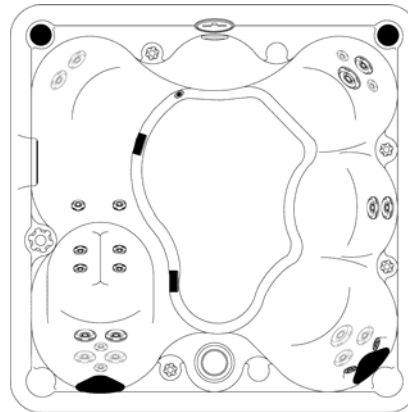

ZONE 1

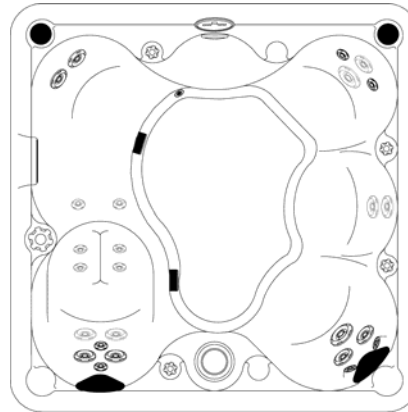

ZONE 2

322™

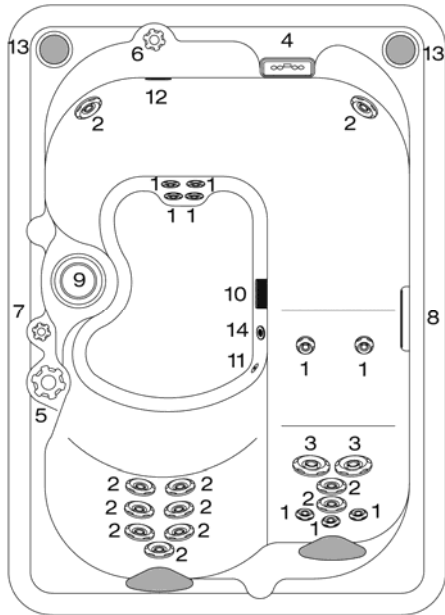

#	Component Identification	Qty.
1	200 Series Jets	9
2	300 Series Jets	11
3	400 Series Jets	2
4	Control Panel	1
5	Jet Selector	1
6	Air Control	1
7	Waterfall Valve	1
8	Waterfall Feature	1
9	Filter Canister	1
10	Suction Fitting	1
11	Floor Drain	1
12	Light	1
13	Stereo Speakers (option)	2

Physical Specifications	Size
Dimensions/mm	2134 x 1524
Height/mm	749
Seating Capacity/Positions	3/4
Weight Dry/Kgs.	186
Weight Full/Kgs.	810
Water Capacity/Litres	623
Total Therapy Jets	22

322 ZONES

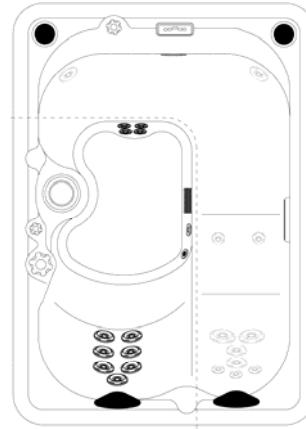

ZONE 2

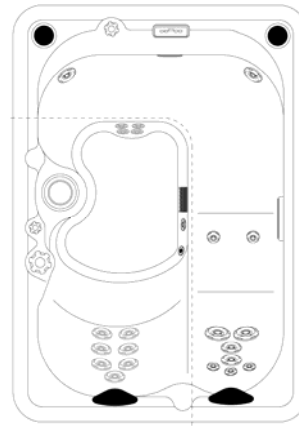

ZONE 1

TROUBLESHOOTING GUIDE

PLEASE NOTE: The following corrective actions may be performed by the spa owner. If the trouble cannot be corrected in the steps below, please contact your authorized Marquis spa dealer for service. (Improper servicing by an unauthorized service provider or spa owner could result in damage not covered by the warranty and could cause serious injury.)

EQUIPMENT WILL NOT OPERATE

- Check the control panel LCD window for diagnostic code.
- Check the circuit breaker on the main circuit panel.
- Check the condition of the power cord.

INADEQUATE JET ACTION

- Be sure the shut-off valves are completely open.
- Open the jets by turning the jet face to allow for maximum water flow.
- Check for obstruction or restrictions at suction guard(s) or filters, such as leaves.
- Check that the water is at proper level, 2/3 up the Vortex skimmer opening(s).
- Inspect the filter cartridge(s) for dirt and debris.

NO HEAT

- Check temperature displayed in the LCD window for desired temperature setting.
- Inspect the filter cartridge(s) for dirt and debris.
- Check that the water is at proper level, 3" above skimmer opening(s).
- Check to make sure spa is in High Range and not in SLEEP MODE.
- Lower ambient temperatures may result in heat loss.

NOTE: Do not expect instant hot water from the jets. It will take the heater 12-24 hours to heat the water to the temperature you desire.

LIGHT DOES NOT WORK

- Press the LIGHT pad on the control panel.
- Reposition the light bulb in the socket. (See REPLACING LIGHT BULB.)
- Replace the light bulb with similar component only.

LCD DIAGNOSTIC MESSAGES

The advanced technology built into the spa allows it to perform a number of self-diagnostic system checks and it can display a variety of messages in the LCD window on the control panel.

TOO COLD: Freeze protection has been activated and no correction action is required. This normal on a fresh fill.

WATR TOO HOT: One of the sensors has reached 110°F. Do not enter the water; contact your dealer for service.

HTR FLOW LOSS: There is not enough water flow through the heater. Clean or install new filter(s) and check that the slice valves are fully open. Call dealer for service.

HTR MAY BE DRY: There is little to no water flow through the heater. Check that the slice valves are fully open. Contact dealer for service.

HTR TOO HOT: One of the sensors has reached 118°F. Do not enter the water. Contact dealer for service.

PRES BTTN TO RSET: Some codes require a button press or power to be removed and restored.

SNSR BAL-- ANCE: The sensors are reading a temperature of 2°F or more. This can occur on a fresh fill, no corrective action required. Contact dealer for service.

SNSR A: Sensor A is non-functional. Contact dealer for service.

SNSR B: Sensor B is non-functional. Contact dealer for service.

MEM FAIL: There is a problem with the firmware. Contact dealer for service.

MEM RSET: Memory has failed. Contact dealer for service.

CLOK FAIL: Clock has failed. Contact dealer for service.

CNFG FAIL: Contact dealer for service.

STUK PUMP: Water may be overheated (DO NOT ENTER THE WATER).

Contact dealer for service.

HOT FALT: A pump may be stuck on. Contact dealer for service.

CHEK PH: Maintenance reminder to check the water pH. Comes up every 7 days, press any button to reset.

CHEK CHEM: Maintenance reminder to check the water sanitizer level. Comes up every 7 days, press any button to reset.

CLN FLTR: Maintenance reminder to clean the filter. Comes up every 30 days, press any button to reset.

CHNG WATR: Maintenance reminder to change the water. Comes up every 90 days, press any button to reset.

CLN COVR: Maintenance reminder to clean the cover. Comes up every 180 days, press any button to reset.

CHNG FLTR: Maintenance reminder to change the filter. Comes up every 365 days, press any button to reset.

MAINTENANCE

WEEKLY MAINTENANCE

1. Removing Debris

Remove any debris and leaves from the Vortex skimmers and suction guard(s) on the inside of the spa. Blocked intakes can impede the flow of water through the jetting system.

2. Water Level

Replenish the water level if necessary so that it is approximately two-thirds up the Vortex skimmer opening. (See STARTING YOUR SPA.) Low and high water levels can damage your spa. It is important to check your water level often.

MONTHLY MAINTENANCE

1. Filter Care

We cannot stress enough the importance of a clean filter for proper water filtration. Dirty filters can restrict water flow, cause hazy water, and prevent your chemicals from working properly. Dirty filters can also cause low flow from jets, poor water clarity and sensors to activate error codes. It is important to clean filters regularly. Many water treatment products clear or clarify the water by clumping microscopic particles and minerals together so that these larger particles can be effectively trapped in the filter. A filter clogged with debris and calcium deposits does not trap particles properly.

The Maintenance Reminder on the spa-side Control Panel indicates a CL every 30 days to remind you to clean your filter.

EVERY THREE TO FOUR MONTHS

Leakage Detection

Open the equipment door and check for signs of water leakage around the pump(s). Pump seals wear out over time, especially with improper water chemistry. Early detection of pump seal failure can significantly reduce repair costs.

Ozonator Operation

The ozonator functions whenever the system is running on filter or clean up cycles. Check to see if the bulb is lighted. The end cap of the ozonator should glow if functioning properly. If not, the bulb has burned out. Contact your dealer for service.

Draining and Filling the Spa

On average, a spa needs to be drained every three to four months. After months of continually adding chemicals to the water and introducing body oils and lotions, the water can be difficult to manage and chemicals are not as effective as usual. You may also notice excessive foaming. More frequent draining may be required depending on use.

Draining the Spa

- Turn off the power to the spa.
- Open the equipment compartment (see EQUIPMENT DIAGRAM). Remove the hose bib cap from the connection and attach a hose.

- C. Open the drain valve. Gravity causes the water to drain out of the hose.
- D. When the spa is empty, close the drain valve and remove the hose. Reinstall the hose bib plug.

NOTE: Keep the drain valve closed at all times except when draining the spa (do not rely on the cap to stop the flow of water). Not doing so could result in damage to the drain valve due to freezing water.

AS NEEDED MAINTENANCE

Cover Care

Proper care of the cover increases the life and keeps it looking great in even the harshest conditions. **NOTE:** Do not use regular household products or products that contain silicone, alcohol, steel wool, or bleach.

Synthetic Exterior Care

Clean the exterior of the spa with a mild soap and water solution. Cleaners that contain alcohol or high levels of solvents, along with Acetone, Nitrobenzene, and Cyclohexanol, can dissolve and discolor the synthetic exterior.

Clean the Acrylic Interior

Once the spa is drained, clean the acrylic interior thoroughly – especially at the water line. Bleach (diluted) is the recommended cleaning agent for acrylic – other products should be avoided except as stated below.

To maintain the high gloss of the acrylic surface just follow these simple steps: For normal care and cleaning use a soft cloth or sponge and water. Rinse well and dry with a soft, clean cloth. Never use abrasive cleaners. Do not allow your acrylic surface to come into contact with products such as ketones or esters such as acetone or ethyl acetate (nail polish remover), Wintergreen oil (methyl salicylate), nail polish, dry cleaning solution or other chlorinated organic solvents, lacquer thinners, gasoline, aromatic solvents, citrus cleaners, pine oil, etc. Remove dust and dry dirt with a soft, damp cloth. Clean grease, oil, paint and ink stains with diluted isopropyl (rubbing) alcohol (do not let alcohol pool or remain on acrylic). Dry with a clean, soft cloth. Avoid using razor blades or other sharp instruments that might scratch the surface.

NOTE: Due to the high-gloss, fine finish of the acrylics, imperfections in the surface texture may occur. A natural aging process in acrylic can lead to a process called crazing. Fine spider web-like lines can form on the cosmetic surface of acrylic over time after exposure to the elements and chemicals. Crazing represents no structural weakening of acrylic and is not covered under the warranty. Fading, staining and discoloration may also occur but represent no structural degradation and are not covered under warranty.

NOTE: Do not leave an empty spa uncovered. Direct sunlight on the spa surface can cause severe damage or blemishing and cause fittings to discolor and can result in the voiding of any surface warranties.

Excess Debris

Grit and debris tracked into the spa should be removed with a spa vacuum.

Water Line

To avoid buildup of oils and lotions at the water line, clean the interior when needed. We suggest the *Glove Sponge* to clean without scratching.

NOTE: Do not use the same brush or sponge to clean the exterior of the spa and the interior of the spa. Soap and other product residue used on the outside of the spa can cause foaming of the spa water and scratches to the spa surface.

Light Bulb Replacement

- A. Turn off the power to the spa.
- B. Remove the equipment area door to find the light access. (See EQUIPMENT DIAGRAM.)
- C. Remove the lamp socket from the back of the light assembly by turning counterclockwise and pulling at the same time.

SUSPENDED USE OR WINTERIZING THE SPA

If you decide to discontinue the use of your spa for any extended period of time, we suggest you follow the steps below.

NOTE: During long periods of inactivity, damage can occur to equipment from condensation within the equipment compartment.

1. Turn off the power to the spa.
2. Drain the spa. (See DRAINING AND REFILLING THE SPA.)
3. Remove all residual water from the seating and footwell. If necessary, bail out the remaining water then dry the spa with towels. A wet/dry vacuum is recommended for best results.
4. Using the wet/dry vacuum, place vacuum nozzle over each jet nozzle to remove water from plumbing lines, starting with the highest jet and finishing with the lowest jet.
5. Unscrew the pump plug(s) from the pump(s). (See STARTING YOUR SPA.)
6. Again, using the wet/dry vacuum, place nozzle over the exposed pump opening(s) to remove excess water. The pump(s) should be removed from the spa and stored in a climate-controlled room.
7. Clean the spa interior.
8. Clean the filter cartridges.
9. Reinstall the spa cover and lock in place.

NOTE: Direct sunlight on the spa surface can cause severe damage or blemishing and can result in the voiding of any surface warranties.

IMPORTANT CHEMICAL SAFETY PROCEDURES

1. Always keep chemicals out of reach of children.
2. Read product labels carefully prior to use.
3. When dissolving, always add chemicals to water, do not add water to chemicals. Some dry chemicals should be dissolved prior to adding them to the spa. Using a clean container, dip some water from the spa. Mix until dissolved, then add to circulating water.
4. **CAUTION:** Do not mix chemicals together. Add them separately to the spa water.
5. All chemical products should be stored in a cool, dry, well-ventilated area where the average temperature does not exceed 90°F (32°C). Keep storage area clean of debris such as rags, newspaper, and combustible materials.
6. Keep chemicals away from open flame or other heat source. Do not smoke near chemicals. If a dry chlorine chemical fire should occur, use water only. Do not use a dry chemical fire extinguisher to attempt to put out the fire.
7. When adding chemicals, always keep the water circulating in the spa with jets in a downward circular pattern for better chemical distribution. Add chemicals to the spa water one at a time. Allow several minutes between any new chemical additions using the jet action to evenly distribute throughout the spa.
8. After adding chemicals, wait the amount of time recommended on the chemical container before retesting your water for an accurate reading. Retest your spa water before using.
9. If you have any questions or concerns about the correct procedures for handling chemicals, please contact your authorized dealer.

WATER CARE

There are three things necessary for clean safe water:

1. CIRCULATE: Water has to be circulated regularly; it can not be stagnant.
2. FILTER: Water has to be filtered to remove particulate and debris.
3. SANITIZE: Water has to be sanitized to kill organisms like algae, bacteria and virus.

The control system in your spa will automatically circulate and filter. (See SPA CONTROL OPERATION.) The sanitation requires minimal effort if done consistently and properly.

To sanitize spa water, three things are required:

1. BALANCE: The water must be balanced so the sanitizer can work and spa equipment is protected.
2. SHOCK: Shock to oxidize organics and maximize sanitizer efficiency.
3. SANITIZE: Maintain a proper level of sanitizer at all times.

WATER CARE TROUBLESHOOTING

P: Problem

S: Solution

Cloudy Water

P: Inadequate filtration or dirty filter.

S: Ensure that the filter is securely installed. Clean or replace filter. Increase the length of clean up and/or filter cycles.

P: Water is not balanced.

S: Test water and adjust pH, alkalinity, and sanitizer as needed. Shock to oxidize and destroy organics in the water.

P: Unfiltered particles or chemically saturated.

S: Use *Water Clarifier* to combine particles.

P: High total dissolved solids

S: Drain, clean, and refill the spa.

Chemical Odour

P: Too many chloramines/bromamines in the water.

S: Treat water with *Spa Shock* then adjust sanitizer level as necessary.

P: Dull looking water, difficult to manage. High total dissolved solids (TDS) may be the cause.

S: Drain and refill with fresh water.

Musty Odour

P: Not enough sanitizer in water – bacteria or algae in water.

S: Add sanitizer as necessary and shock. Readjust sanitizer level if necessary.

Yellow Water

P: Low pH and/or low alkalinity.

S: Test and adjust pH with *pH and Alkalinity Up*. Adjust alkalinity if necessary.

Foaming

P: High concentration of body oils, lotions or soaps, as well as excessive organics.

S: Use *Spa Defoamer* and adjust pH and sanitizer as needed.

Scum Line in Spa

P: Body oils and dirt.

S: Use *Glove Sponge* to clean the spa. Test and adjust the sanitizer and pH if necessary. Increase the clean up cycle.

No Sanitizer Reading

P: Sanitizer level is too low.

S: Shock until the sanitizer registers in the recommended range.

P: Test strip remains "white" even after sanitizer has been added.

S: Sanitizer level could be extremely high. It can bleach the reagents on the test strip and give a false reading. Remove spa cover and activate jets and air control. Allow jets to run for 30 minutes. Test water to see if desired level has been reached.

High Sanitizer Reading

P: Too much chlorine or bromine added or dispensed into the spa.

S: Remove spa cover and activate jets and air control. Allow jets to run for 30 minutes. Test water to see if desired level has been reached. Reduce bromine level.

Eye or Skin Irritation

P: Contaminants or excessive amount of chloramines/bromamines in water.

S: Treat water with *Spa Shock*. Adjust sanitizer level.

P: pH is low.

S: Adjust as needed.

Corrosion of Metal

P: Low pH.

S: Adjust pH with *pH and Alkalinity Up*.

Green Water/Algae

P: Low sanitizer level or high pH.

S: Adjust pH and shock as necessary.

Erratic pH

P: Alkalinity and/or calcium hardness are too low causing pH "bounce".

S: Test and adjust alkalinity and/or calcium hardness to bring them into the ideal range.

LIMITED WARRANTY

WHAT THE MARQUIS CORP. LIMITED WARRANTY COVERS

Marquis Corp. warrants that our products will be free from defects in materials and workmanship for the term set forth exclusively in this warranty. Accessories purchased from Marquis Corp. or a Marquis Corp. authorized dealer and added to the spa after manufacture of the spa are not covered under this warranty but may have other warranties. Refer to owner's manual for proper use, maintenance and installation of your spa. The Limited Warranty is made only to the original purchaser of the spa and is not transferable.

- [5] **STRUCTURE:** The fiber glass structure is warranted for five years not to leak. Fittings and attachments are not included.
- [2] **SURFACE:** The acrylic surface is warranted for two years against blisters, cracks and delamination.
- [2] **PLUMBING:** Plumbing and fittings are warranted against water loss for two years. Warranty coverage does not include gaskets or seals.
- [2] **EQUIPMENT:** Electronic equipment is warranted against defects in materials and workmanship for two years. Equipment includes equipment packs, PC boards, pumps, control panels, heater and heat sensors.
- [1] **EXTERIOR:** The synthetic skirt exterior is warranted against cracking and peeling for one year.
- [1] **COMPONENTS:** The ozonator and GFCI are warranted against defects in material and workmanship for one year.
- [1] **PARTS:** LED lights, remote controls, valves, spa cover, stereo components, jet inserts and overlays are warranted for one year. These parts do not qualify for labor coverage under this warranty. Fuses, non-LED lights, filter, filter lid, cushioned headrests and other items not specifically mentioned in this warranty are warranted to be free from defects in materials and workmanship at time of delivery. These parts do not qualify for labor coverage under this warranty.

TERM OF THE MARQUIS CORP. LIMITED WARRANTY

The term of your warranty begins on the date the product is sold to you and continues for the term described in this warranty for each component.

WHAT YOU SHOULD DO IF YOU EXPERIENCE A PROBLEM

Unless otherwise designated in writing by Marquis Corp., Marquis Corp. or its agent are the only parties authorized to perform warranty service on Marquis Corp. spas. Upon experiencing a problem, please contact your authorized dealer. You will be asked to provide the following information when requesting warranty service: your name, address and contact information; serial number; a description of your spa and a description of the problem. You will be required to provide proof of purchase of your spa prior to receiving warranty service.

WHAT MARQUIS CORP. WILL DO IN THE EVENT OF A PROBLEM

Marquis Corp. agrees to repair any plumbing or surface defects and to repair or furnish a replacement for any factory-installed component covered under this warranty which, upon test and examination by Marquis Corp., proves to have manufacturing defects. All materials for examination must be returned to Marquis Corp. freight prepaid. Marquis Corp. will provide parts and labor where applicable (according to predetermined schedule) at no charge to repair or replace components that fail due to manufacturing defects. Responding authorized dealer may charge additional service and travel fees. In the event that Marquis Corp. or its agent determines that your problem can be addressed by providing a replacement part to you for installation in your spa, a replacement part will be provided to you at no charge when you return the defective part. All replacement parts assume the original warranty status of the spa into which they are installed, including time remaining on warranty, and have no separate or independent warranty of any kind. To facilitate repairs, Marquis Corp. or its agent may require access to spa equipment. It is your responsibility to provide unencumbered access.

WHAT THE MARQUIS CORP. LIMITED WARRANTY DOES NOT COVER

No warranty will apply to any spa that has been (i) modified, altered or adapted without Marquis Corp.'s written consent; (ii) maltreated or used in a manner other than in accordance with the spa owner's manual; (iii) repaired by any third party not authorized by Marquis Corp.; (iv) improperly installed by any party; (v) used with equipment not covered by this warranty, to the extent that problems are attributable to such use; (vi) relocated to the extent that problems are attributable to the relocation; (vii) located on any support surface other than specified in the spa printed instructions; and (viii) damage caused by pH level

outside the range of 7.4 to 7.6 and other chemical abuse. Refer to instructions in the owner's manual for proper use, maintenance and installation of your spa. Other costs not included in this warranty are freight expenses; labor and material cost associated with removal and or replacement of the spa; damage to or fading of the spa surface and staining of the spa surface or equipment caused by impact, scratching, abrasive or corrosive cleaners; damage due to extreme water temperatures outside the range of 32°F to 120°F (0°C to 49°C) even if the damage was the result of a covered failure; or damage to the spa surface or equipment caused by acts of nature, including wind and power surges. Damage to the spa surface and fittings caused by leaving the spa uncovered and empty of water with direct exposure to sunlight may cause solar heat distress and also invalidates this warranty.

Other costs not associated with the direct repair of the spa, such as phone charges and missed work are not included in this warranty. In the event that the Marquis Corp. serial number tag on the spa has been removed or tampered with, the warranty will be void. Customer may not dismantle spas, and any attempt to dismantle systems, other than described herein, constitutes a modification or alteration of the spa which voids the applicable warranty.

LIMITATIONS

Your sole and exclusive remedy and Marquis Corp.'s entire liability in connection with manufacture and sales of its spa products is repair or replacement (at Marquis' option) of a defective part, as expressed in the limited warranty. Any other express or implied representation or warranty, including the implied warranties of merchantability and of fitness for a particular purpose as well as non-infringement, is excluded to the maximum extent permitted by law. Except as may be required by applicable law, Marquis Corp. shall not be liable for injury, loss, or damage to person or property, however arising, in connection with manufacture or sale of its spa products. This includes indirect, punitive, special, incidental, or consequential damages (including but not limited to loss of use) whether the claim for such injury, loss, or damage is based on breach of contract, breach of warranty, or tort, even if Marquis Corp. has previously been advised of the possibility of such damages.

This limited warranty gives you specific legal rights, and you may also have other rights which vary from state to state.

STEREO SYSTEM ONE YEAR LIMITED WARRANTY

Marquis Corp. warrants to the original retail purchaser, the components of the stereo system will be free from defects in material and workmanship for a period of one year from date of purchase. One year coverage includes parts. Labor is covered for 90 days and is based on a predetermined schedule. Optional remote and IR/RF sending unit not included in this warranty; other warranties may apply from the original manufacturer of the optional remote. The stereo system Limited Warranty is made only to the original purchaser of the spa and is not transferable.

In no event shall any obligation of Marquis Corp. extend beyond the original period of any applicable warranty determined according to the effective warranty date of the original purchaser.

PERFORMANCE OF WARRANTY

Marquis Corp. agrees to repair or furnish a replacement for any defects in stereo system material or workmanship which upon test and examination by Marquis Corp. proves defective. Stereo components including CD player/radio, speakers, subwoofer, mechanical speaker lift device, stereo access door, power supply are warranted against defects in material and workmanship for one year. Labor to replace stereo components is covered for 90 days. Water intrusion of any kind is not covered. All materials for examination must be returned to Marquis Corp. freight prepaid. Your authorized Marquis Dealer reserves the right to assess travel charges for service calls.

INVALIDATION OF WARRANTY

This warranty is void if the stereo system has been subjected to alteration, misuse or abuse or if any repairs on the stereo system are performed or attempted by anyone other than an authorized Marquis Corp. service center. Alteration is defined as any component change, electrical conversion or the addition of any alternative sound system components which contribute to component failure.

Misuse and abuse shall include without limitation any external power source attached to the stereo system other than approved source, or use in a particular manner that the stereo system was not designed, or operation of the stereo system other than in accordance with Marquis Corp. printed instruction (located in the Owner's Manual) that leads to any component failure. Under no circumstances shall Marquis Corp. or any of its representatives be held liable for injury to any person or damage to any property, however arising.

Other costs not associated to the direct repair of the spa, such as phone charges, missed work, and damage caused to the stereo system beyond Marquis' control, are not included in this warranty. Items beyond Marquis control include but are not limited to damage resulting from: improper connections, accidents, failure to follow procedures defined in the Owner's Manual, damaged from excessive wattage to the system, lightning, extreme temperatures or any other natural occurrences.

DISCLAIMERS

There are no additional warranties, express or implied, which extend beyond the terms of this limited warranty. Marquis Corp. makes no warranty of merchantability of the goods or the fitness of the goods for a particular purpose. No other person or entity has been authorized to make any warranty, representation or promise of performance not included in this express written warranty, and Marquis Corp. shall not be bound by any such additional warranty, representation or promise.

IMPORTANT: Some jurisdictions do not allow the exclusion or limitation of incidental or consequential damages, therefore the limitation or exclusions may not apply to you.

©Copyright Marquis Corp. 11/2010