

We sincerely hope your spa life is a pleasant experience. If problems should arise, contact your authorized Marquis Spas® dealer. Or contact Marquis Corp. at any of the following:

Email: service@marquiscorp.com
 Web: www.marquisspas.com
 Marquis Corp.
 596 Hoffman Road
 Independence, OR 97351, USA

This manual is provided to enhance your enjoyment of your spa and to prevent non-warranty situations. It is your sole responsibility to read, understand and comply with the instructions in the owner's manual. Please save your original sales receipt for reference in case of a future warranty claim. Failure to use, maintain or install the spa in compliance with this owner's manual could result in loss of warranty coverage.

PRODUCT REFERENCE

SERIAL NUMBER LOCATION

You will find the serial number in the equipment area.

PLEASE FILL OUT AND KEEP FOR FUTURE REFERENCE

Name of Purchaser _____
 Date of Purchase _____
 Address _____
 City _____ Country/Province _____
 Postal Code _____
 Spa Model/Colour _____
 Spa Serial No. _____
 Pack Serial No. _____
 Dealer's Name _____
 Dealer's Address _____
 City _____ Country/Province _____
 Postal Code _____
 Telephone _____

Every effort has been made to ensure the accuracy of this manual. However, Marquis Spas® reserves the right to improve its product without notice. This could create a minor variation between this manual and the actual product you receive. We apologize for any inconvenience this may cause.

SEPARATE WASTE COLLECTION



This symbol indicates the need for separate waste collection of electronic and electrical equipment. Please do your part in protecting the environment and human health by reusing and recycling used electronic equipment whenever possible. Please do not dispose of such equipment as unsorted municipal waste. This product was put on the market after August 13, 2005.

Marquis Spas® is fully compliant with the European Union Council Directive 2002/95/EC (restriction of Hazardous Substances – RoHS).

Additionally, products are marked according to Annex IV of Council Directive 2002/96/EC (Waste Electrical and Electronic Equipment – WEEE) which addresses the handling of products at the end of their useful life.

OWNER'S MANUAL INDEX

IMPORTANT SAFETY INSTRUCTIONS
 All Spa Models 2
 Personal Safety..... 2

INSTALLATION INSTRUCTIONS
 Location..... 3
 Filter Cartridges..... 3
 Electrical Requirements..... 4

STARTING YOUR SPA 4-5

SPA CONTROL OPERATION
 Destiny, Envy, Euphoria, Mirage, Promise, Rendezvous, Resort, Reward, Spirit, Wish..... 6-7
 Epic, Show... 7-8
 Adagio™ Audio System..... 9
 Aquavision Unit..... 9

EQUIPMENT DIAGRAMS
 All Models..... 10

SPA MODELS
 Destiny..... 11
 Envy..... 11
 Epic..... 12
 Euphoria..... 12
 Mirage..... 13
 Promise..... 13
 Rendezvous..... 14
 Resort..... 15
 Reward..... 15
 Show..... 16
 Spirit..... 17
 Wish..... 17-18

TROUBLESHOOTING..... 19
 LCD Diagnostic Messages 19
 Maintenance Reminders..... 19

MAINTENANCE..... 19-20

MARQUIS SPA CARE..... 20-21
 Water Care Troubleshooting..... 21

OWNER'S PROTECTION PLAN..... 22
ADAGIO™ AND AQUAVISION LIMITED WARRANTY..... 23



WARNUNG: Bevor Erhaltungszugriff auf Terminale, müssen alle Versorgungskreisläufe abgeschaltet werden.

WARNING: Before obtaining access to terminals, all supply circuits must be disconnected.

SAFETY INSTRUCTIONS

The following instructions contain important safety information. We strongly encourage you to read and apply them.

IMPORTANT SAFETY INSTRUCTIONS

WHEN INSTALLING AND USING THIS ELECTRICAL EQUIPMENT, BASIC SAFETY PRECAUTIONS SHOULD ALWAYS BE FOLLOWED, INCLUDING THE FOLLOWING:

1. **READ AND FOLLOW ALL INSTRUCTIONS.**
2. **WARNING:** To reduce the risk of injury, do not permit children to use this product unless closely supervised at all times.
3. **DANGER: RISK OF CHILD DROWNING.** Extreme caution must be exercised to prevent unauthorized access by children. To avoid accidents, ensure that children cannot use the spa or hot tub unless they are supervised at all times.
4. **WARNING:** Disconnect all supply circuits before obtaining access to the terminal.
5. A ground/earth terminal is provided on the terminal block located on the outside of the control box. To reduce the risk of electric shock, connect this terminal to the grounding/earth terminal of your electrical service or supply panel with a continuous green/yellow, insulated copper wire. The wire must be equivalent in size to the circuit conductors supplying the equipment. In addition, a bonding terminal (pressure wire connector) is provided on the outside of the control box for bonding to local ground/earth points. To reduce the risk of electric shock, this connector should be bonded with a No. 8 AWG (8.42mm²) solid copper wire to any metal ladders, water pipes, or other metal within five feet (1.5m) of the spa to comply with local requirements.
6. Your spa uses ground fault circuit interrupters (GFCIs) or residual current devices (RCDs) in the electrical sub-panel. Before each use of the spa and with the unit operating, press the Test button on each breaker. The switch should click over to the "Trip" position. Wait thirty seconds and reset each RCD breaker by switching it completely off and then completely on. The switch should then stay on. If either of the interrupters does not perform in this manner, it is an indication of an electrical malfunction and the possibility of an electric shock. Disconnect the power until the fault has been identified and corrected.
7. Install the spa so proper drainage is provided for the compartment containing the electrical components.
8. **DANGER: RISK OF ELECTRIC SHOCK.** Do not permit any appliance, such as a light, radio, telephone, or television within 1.5m of the spa or hot tub.
9. **WARNING: TO REDUCE THE RISK OF INJURY.**
 - The water in the spa should never exceed 40° C. Water temperatures between 38° C and 40° C are considered safe for a healthy adult. Lower water temperatures are recommended for extended use (exceeding 10 minutes) and for young children.
 - Since excessive water temperatures have a high potential for causing fetal damage during the early months of pregnancy, pregnant or possibly pregnant women should limit spa water temperatures to 38° C.
 - Before entering a spa, the user should measure the water temperature with an accurate thermometer since the tolerance of temperature-regulating devices may vary as much as +/- -3° C.
 - The use of drugs, alcohol, or medication before or during spa use may lead to unconsciousness with the possibility of drowning.
 - Persons suffering from obesity or with a medical history of heart disease, low or high blood pressure, circulatory system problems or diabetes should consult a physician before using the spa.
 - Persons using medications should consult a physician before using a spa since some medication may induce drowsiness while other medication may affect heart rate, blood pressure, and circulation.
10. **DANGER: TO REDUCE THE RISK OF INJURY TO PERSONS.** Do not remove the suction fittings.
11. **DANGER: RISK OF INJURY.** Never operate a spa if the suction fitting(s) are broken or missing. Never replace a suction fitting with one rated less than the flow rate marked on the original suction fitting. The suction fittings in the spa are sized to match the specific water flow created by the pump. Should the need arise to replace the suction fittings or the pump, be sure that the flow rates are compatible.
12. **DANGER:** Children are especially sensitive to hot water. At no time should children have unsupervised access to the spa. Children must not be allowed to climb onto the spa cover. All Marquis Spas are equipped with a

locking safety cover. Always lock the child resistant locks after using the spa for your children's safety.

13. **CAUTION:** To reduce the number of airborne bacteria in an enclosed spa area, proper ventilation must be provided.
14. **WARNING:** The design and construction of this spa are in accordance with all applicable regulations. Modifying or adding spa components may affect proper spa functioning, and may void the compliance markings.
15. **SAVE THESE INSTRUCTIONS.**

PERSONAL SAFETY

Prolonged immersion in hot water can result in **HYPERTHERMIA**, a dangerous condition which occurs when the internal temperature of the body reaches a level above normal (37°C). The symptoms of hyperthermia include dizziness, fainting, drowsiness, lethargy, and a body temperature above 37°C. The physical effects of hyperthermia include unawareness of impending hazard, failure to perceive heat, failure to recognize the need to exit the spa, physical inability to exit the spa, fetal damage in pregnant women, and unconsciousness resulting in a danger of drowning.

WARNING: The use of alcohol, drugs, or medication can greatly increase the risk of fatal hyperthermia in hot tubs and spas.

Persons taking medications which induce drowsiness such as tranquilizers, antihistamines, or anticoagulants should not use the spa. Pregnant women and persons with a medical history of heart disease, diabetes, or high blood pressure should consult a physician before using the spa.

PERSONAL SAFETY DOS:

- Be sure your spa is connected to the power supply correctly – use a licensed contractor.
- Disconnect the spa from the power supply before draining the spa or servicing the electrical components.
- Test the RCD monthly.
- Test the water temperature with your hand before entering the spa to be sure that it's a comfortable temperature.
- Do not use the spa if water temperature is outside of set temperature.
- Remember that wet surfaces can be very slippery. Take care when entering and exiting the spa.
- Use the safety cover when the spa is not in use, whether it is empty or full of water.
- Keep the water clean and sanitized with correct chemical care.
- Turn on the jets when adding ANY spa water chemicals.
- After running the pump for three consecutive 15 minute periods (if so desired), allow for a 30 minute cool-down period.
- Clean the filter cartridge(s) monthly to remove debris and mineral buildup which may affect the performance of the hydrotherapy jets, limit the flow, or trip the high limit thermostat which will turn off the entire spa.

PERSONAL SAFETY DON'TS:

- Don't use the spa with the equipment compartment door removed.
- Don't use the spa for long periods of time at water temperatures in excess of 40°C.
- Don't allow the jet pump(s) to operate for an extended period of time with the cover in place. Extended pump operation will cause a slow heat buildup due to water friction. The spa equipment controls are equipped with a built-in safety timer that will automatically shut off the jet pump(s) after 15 minutes of continuous operation should it have been left on inadvertently.
- Don't operate the spa at any time with the filter cartridge(s) removed.
- Don't lift or drag the cover by using the tie-down straps or cover skirting; always lift and carry by using the external handles.
- Don't store chemicals in the spa's equipment compartment.

INSTALLATION INSTRUCTIONS

LOCATION

For your portable spa to function properly and safely, it must be located on a hard, flat, level surface. Inground spas require special installation techniques and should be planned in conjunction with your authorized Marquis Spas® dealer. Improper installation can result in structural damage to the spa and the voiding of your spa warranty. Items to discuss with your dealer include: local construction codes, electrical service requirements, serviceability of equipment, existing underground obstructions such as gas, water, and telephone lines, safety measures such as fences and locks, and visibility of the spa installation from the home, street, and neighbours.

- Do not shim your spa. If your pad is not level you must pour a top cap: contact a professional.
- Allow for sufficient water drainage around the spa to help preserve the equipment and support structure. This includes indoor installations.
- A filled spa can weigh up to 2268 Kg and the location must support the weight of the filled spa.
- Locate the equipment compartment where it will be accessible. Your spa **MUST** be installed to permit access for servicing the equipment above and/or below any decks or floors. Access is essential and must allow adequate room for service. To facilitate repairs, Marquis Corp. or its agent may require access to spa equipment. It is your responsibility to provide unencumbered access. See spa diagrams for location of power supply.
- Leave access to the circuit breakers in the sub panel.
- Be sure the spa is level and in the final position **BEFORE** filling with water. Check for power cords, tools, and hoses that may be caught underneath the spa.
- Do not apply power to the spa before it is completely filled with water. Damage to the pumps, heater and sensors may result.
- **IMPORTANT: DO NOT LET AN EMPTY SPA REMAIN EXPOSED TO DIRECT SUNLIGHT.** Spa surface temperatures can reach in excess of 82°C if left exposed to the sun. Significant damage can occur if this is allowed to happen, including warping and blistering of the surface and components. Damage that occurs as a result of this exposure is not covered under the warranty.
- **CAUTION:** Never try to move a spa that has not been fully drained. To do so could result in damage to the spa and physical injury to the mover.
- Cracks in the spa surface, exterior siding or DuraBase due to improper transport or support of the spa are not covered under the warranty.

OUTDOOR AND PATIO INSTALLATION

To install the spa outdoors, we recommend a reinforced concrete pad at least 10 cm thick. The reinforcing material should be grounded per electrical codes.

If you place the spa on the ground, even temporarily, place the spa empty of water on concrete pavers under the entire bottom of the spa. The concrete pavers should be at least 5 cm thick and level across the entire surface. The spa will inevitably settle and become out of level on this surface, thus it is important to get the spa onto a solid foundation as soon as possible.

INSTRUCTIONS FOR PREFABRICATED SPA PADS

If you are using a prefabricated spa pad for a foundation, please use the following guidelines:

1. Designate the area where the spa is to be installed. Please make sure the ground is flat and level.
2. Using 2"x 6" weather resistant lumber and 3" outdoor deck screws, build a frame large enough for the prefabricated spa pad to fit inside with minimum 1" clearance on all sides.
3. Install the frame in the area that has been leveled.
4. Using pea gravel, please fill the frame to the top.
5. Lay a straight piece of lumber across the frame and level any high spots in the gravel by pushing the straight lumber across the frame. Fill in any low areas with more gravel and re-level using the straight piece of lumber.
6. Compact the gravel to make the surface is hard and flat. You may need to add more gravel to bring the level back up to the top of the frame. If so, please re-level and re-compact until you have a hard, flat level surface that is even with the top of the frame.
7. Place the prefabricated spa pad on top of the gravel. Please be careful not to disturb the hard, flat, level surface.

8. Please make sure no portion of the spa pad is sitting outside or on top of the framing.
9. Place the spa on top of the pad and fill the spa with water.

DECK INSTALLATION

Be sure the deck can support the weight of your filled spa by checking the deck's maximum load capacity. Consult a qualified building contractor or structural engineer. Minimum requirement is 45.36 Kgs. per 9.3 cm.

INDOOR INSTALLATION

There are special requirements if you place your spa indoors. Flooring material must provide adequate traction when wet. Proper drainage is essential to prevent water pooling. To avoid increased humidity, you need to provide proper ventilation to the area. The addition of a ventilation system is recommended.

SHUT-OFF VALVES

Your spa is equipped with shut-off valves (see EQUIPMENT DIAGRAM) that shut off the water flow to the equipment system for authorized Marquis Spas® dealer service. At times, a new spa or one that has recently been serviced may have the shut-off valves partially closed which can restrict the water flow and hinder jet performance. Be sure the valves are fully open.

FREEZE PROTECTION

When a freeze condition is detected (which occurs when the temperature in the heater housing drops to 13°C), the jet pump(s) is automatically activated. In areas with extremely cold winter conditions, your spa should be fine as long as it is left running at normal operating temperatures. If you plan to turn the spa off, follow the instructions in this manual (see SUSPENDED USE OR WINTERIZING YOUR SPA).

OVERHEATING

In the case of extended hot weather, the spa water temperature may reach and maintain 40°C to 41°C or higher. This is due to the ambient temperature and the full insulation in the spa cabinet. You may have the option of shortening the pump-run time. (See SPA CONTROL OPERATION for available options.)

FILTER CARTRIDGE(S)

Your portable spa features one or two Vortex filters.

Filter cartridges and filter lids are warranted to be free of defect at time of delivery and do not qualify for labor coverage under the warranty. These parts can be purchased or exchanged at your authorized Marquis Spas® dealer.

NOTE: It is very important that the components of these filtration systems be installed properly in the proper part of the spa.

1. Hold the Vortex filter cartridge and center it in the opening of the filter housing.
2. Use the filter handle and turn the filter cartridge clockwise to screw it in place. (Use caution not to over tighten as damage may occur to threads and is not covered under warranty.)
3. Grasp the edge of the Vortex skimmer lid or Waterfall tray, center it over the rings and gently snap in place. For Show spa, gently place the tray in position resting the center point in the groove.

SUCTION GUARDS

The suction fitting(s) in the footwell of your spa is an opening through which the jet pump(s) draws water. Suction fittings are equipped with a safety guard. Suction through the fittings can be strong. The safety guard(s) must remain in place and undamaged. A fitting with a damaged guard(s) can be dangerous, especially to small children or people with long hair. Should any part of the body become drawn to a fitting, immediately turn the jet pump(s) off. Long hair should be restrained. Never allow long hair to float freely in the spa. Replace any missing or damaged suction guard(s).

NOTE: It is normal for the flow rates of the suction fittings to vary from strong to barely noticeable.

ELECTRICAL REQUIREMENTS

It is the responsibility of the spa owner to ensure that all electrical connections are made in accordance with all electrical codes in effect at the time of installation including proper bushings (at least 1 mm in diameter) at the spa

control and at the appliance openings. The recommended spa operating environment is -5°C to +45°C, at 20-80 percent of relative humidity. Fuses are covered to be free of defect at time of installation only.

Electrical Supply:

Insert the incoming electrical service line through one of the access holes on either side of the spa base (remove plastic plug). Then insert the service through the electrical access hole of the control box (see diagrams).

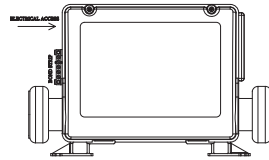

A pressure wire connector is located on the exterior of the control box. If the installation includes a common bonding grid (reinforced concrete slab, ground/earth plate beneath the spa, or any metal water pipe connection), this pressure wire connector should be bonded to any metal ladder, water pipe, or other metal, within 1.5 m of the spa and in accordance with pertinent electrical codes.

220-240V AC, 50 Hz:

Connections shall be made in accordance with the wiring diagram found on the inside of the control box cover. Connections should be made with copper conductors only – aluminum wiring should not be used with this system. All conductors, circuit breakers, and/or fuses must be sized in accordance to the input ratings shown below:

220-240 V AC, 50 Hz:

- Permanently connected
- Rated 220-240V AC – 50 Hz
- One and two pump spas are rated 16A for low amp setting (heater off during high-speed) and 32A for high amp setting (heater on during high-speed).

Improperly wired spas can cause irreversible damage resulting in blown fuse and melted terminal block, and to other electrical components. Also, damage caused to components or equipment caused by high or low voltage, brown outs or electric surges is not covered under warranty.

Electrical Service Connections at Terminal Block, Inside Spa Controller:

The spa must be supplied through a single MCB with a certified residual current device (RCD) with a rated current trip not exceeding 30 mA. Means for spa disconnection from supply must be incorporated in the fixed wiring. Recommended supply conductor nominal cross sectional area is 4mm² for 16A rating, 6 mm² for 32A rating.

NOTE: If the power cord on any piece of electrical equipment, such as a jet pump or ozone generator, becomes damaged, do not use the spa until the cord has been repaired. Consult your authorized Marquis Spas® dealer for

assistance on such repair.

Electrical Diagram: 322, 435, 545, 660

Improperly wired spas are beyond Marquis Corp. control and are not covered under the warranty. Other items beyond Marquis Corp. control include, but are not limited to, damage resulting from: improper connections; accidents; failure to follow procedures and instructions defined in the Marquis Spas® printed instructions; cleaning agents; and natural occurrences including but not limited to rodent or insect infestation, mold, lightning and other acts of nature.

Single 32A line of service.



For heater OFF during high speed - jumper 10 on (up).
For heater ON during high speed - jumper 10 off (down).

2 16A lines of service.
(Remove jumper A)

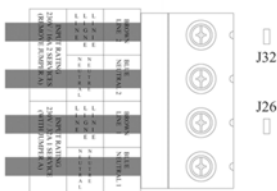

For heater OFF during high speed - jumper 10 on (up).
For heater ON during high speed - jumper 10 off (down).

STARTING YOUR SPA

START-UP PROCEDURE

Your spa is equipped with solid-state Comfort Controls specific to your spa model. (See SPA CONTROL OPERATION for your specific spa model.)

To start your spa, you need a spa water test kit or test strip and an underwater thermometer. It is important to follow each of these steps when starting your spa. Once you have completed the following steps, refer to the instructions in your start-up kit for proper start-up water maintenance, or see MARQUIS SPA CARE.

NOTE: Your spa has been filled and test-run at the factory. The first time your spa is filled with water, some discoloration from residual test water may appear. This will disappear when the spa is completely filled and the filtration system is functioning.

WARNING: Spa must be completely filled with water before turning on power.

Test the water for the proper chemical balance and adjust as necessary. Marquis SpaCare™ products are recommended. (See WATER TREATMENT.) **PROPER CHEMICAL BALANCE IS IMPORTANT** for your safety and the longevity of your spa.

In the case of relocating your spa, it is imperative to follow the instructions in the owner's manual. These instructions must remain with the spa. Damage caused by relocating spa is not covered under warranty.

THERAPY PUMP(S)

Start-up procedure for all models

1. Place spa on a hard, flat, level surface. Make sure the power supply is off.
2. Make sure the suction guard(s) in the footwell are in place and undamaged.
3. Open the equipment door. Tighten all disconnects and open all shut-off valves.

NOTE: Keep the drain valve closed at all times except when draining the spa (do not rely on the cap to stop the flow of water). Not doing so could result in damage to the drain valve due to freezing water.

4. Install filter cartridges. (See INSTALLATION INSTRUCTIONS, Filter Cartridges.)
5. Fill the spa with water to two-thirds of the way up the Vortex skimmer openings.
The use of a Fill Filter is recommended, especially in areas with high mineral content in the water.
6. Turn the power on.
7. Allow the spa to circulate on high-speed (see SPA CONTROL OPERATION) for four to five minutes to discharge air from the plumbing system. Do not expect hot water immediately from the jets; the heater will take several hours to heat the water.
8. Your spa is now in "pump priming" mode and a "Pr" message displays in the LCD window of the control panel. While in this mode the spa appears idle, which lasts approximately four to five minutes if not exited manually. To exit manually, press the TEMP pad.
9. At this time, the spa should have water flowing from the jets. If the pump has not primed and the water is not flowing from the jets after two minutes, TURN OFF POWER TO THE SPA and vent air from the pumps by slightly opening the pump unions. After turning the power on again, the spa initiates a new priming mode. Repeat steps above.
10. The system requires approximately two minutes of water flow to determine the water temperature. After two minutes of water flow, the temperature is displayed as actual water temperature. After you have manually exited the priming mode (or allowed the spa to automatically exit), the LCD window momentarily displays 37°C and then the display switches to -- °C.
11. The factory default setting for water temperature is 37°C. Use the TEMP pad on the control panel to set the water temperature to the desired level. (See SPA CONTROL OPERATION.) Your spa heats at the rate of approximately 3°C per hour.

DURACOVER™

When the spa is not in use, the cover should be kept on the spa to retain the water's heat and to keep out dirt, leaves, etc.

For your safety and convenience, the cover is equipped with adjustable straps, safety locks, and handles. Use the exterior handles to remove and replace your cover. Never attempt to open or remove the cover by grasping or pulling on the cover skirting or cover lock straps as the skirting will tear.

Marquis suggests you use the safety locks to help keep out unintended users and prevent covers from being blown off in windy conditions. The cover and retractable cover system are not recommended for use in wind conditions reaching above 40 km/h. If your spa is located in an area susceptible to high winds, additional cover lock straps may be necessary to minimize cover damage.

Open the spa cover:

1. Unfasten all cover lock straps.
2. Place one hand under the cover skirting, between the spa and cover, to break the cover's vacuum seal. Do not use cover handles to break vacuum seal.
3. Fold the front half of the cover over onto the back half.

NOTE: Unlock and release all cover locks before attempting to open cover. Damage caused by attempting to open the cover while locked or by wind is not covered under warranty. Do not walk, stand, climb, or sit on the vinyl cover or retractable cover system. Do not use hard, sharp, or metal objects, such as a windshield scraper, to remove ice. Such objects can cut, mar, or puncture the cover's vinyl surface.

Close the spa cover:

1. Place one hand on the upper corner of the cover and gently push forward in the direction of the spa. The cover will rotate forward to cover half of the spa.
2. Unfold the cover by lifting the handle located on the top (front) half of the cover. Allow the unfolded half to fall down onto the spa.
3. Secure the cover lock straps to the spa and lock them.

NOTE: When opening a cover with a cover removal mechanism, use one of the manufacturer's recommended methods. Do not attempt to open the cover in any other way. Damage caused by improper opening or closing of the cover is not covered under the warranty.

Fading, staining, torn stitching of the spa cover and broken foam cores are not covered under the warranty for any reason. Spa covers do not qualify for labor coverage under the warranty. These parts can be purchased or exchanged under warranty at your authorized Marquis Spas® dealer.

SPA CONTROL OPERATION

Destiny, Envy, Epic, Euphoria, Mirage, Promise, Rendezvous, Resort, Reward, Spirit, Wish

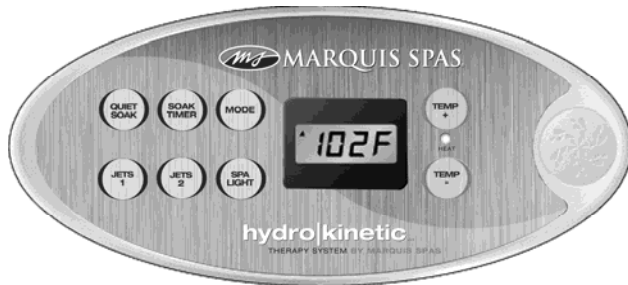

PUMP PRIMING (Pr)

Pump priming feature begins at start-up. When your spa is energized, the LCD window displays a "Pr" message. This mode lasts approximately four to five minutes, if not exited manually by pressing the TEMP+ pad.

UNDERWATER LIGHTS

Press the LIGHT pad on bather's panel to turn the underwater lights on and off. The low-voltage system produces a night light for evening use. After being on for 60 minutes, the lights automatically turn off. For Aqua Ambiance and Constellation use SPA LIGHT pad. Step one: turn on light. Step two: turn off and then on within 2-3 seconds to change color.

NOTE: LED lights do not qualify for labor coverage. These parts can be purchased or exchanged under warranty at your authorized Marquis Spas® dealer.

WATERFALL FEATURE

The water flow is controlled by an independent valve.

JETS 1 (One Pump Models)

Use the JETS 1 pad on the bather's panel control. First press of the JETS 1 pad activates pump on low-speed (and starts soak timer). Second press of the JETS 1 pad activates pump on high-speed. Third press of the JETS 1 pad turns jets off for Quiet Soak mode. If the system is in a filter cycle or calling for heat, low speed will continue to run. The high and low speed operation will stop after 15 minutes of use. To restart the pump, press the JETS 1 pad. The yellow LED indicator by the JETS 1 pad will illuminate anytime the pump is running.

JETS 2 (Two Pump Models)

Press JETS 2 pad to turn on pump two to low speed. Pressing a second time will turn the pump on high speed. Pressing a third time will turn the pump off. The high speed of pump two will run for 15 minutes and then switch to low speed. Once on low speed, the pump will run for 15 minutes and then shut off. To restart the pump to your desired speed, press the JETS 2 pad. The yellow LED indicator by the JETS 2 pad will illuminate anytime the pump is running.

AUXILIARY JET CONTROL (Euphoria & Wish)

Your spa may be equipped with either one or two additional jet pump controls. The controls operate the pumps in the seat adjacent to the controls in the same manner that the master panel does. Pressing the pad once will turn the jet pump on low speed, pressing again will turn the jet pump on high speed, and pressing again will turn the jet pump off. If you are controlling the primary jet pump, it may continue to run on low speed if the spa is in a filtration cycle or is calling for heat.

ADAGIO™ II AUDIO SYSTEM (OPTION)

Adagio™ II provides a safe enclosure and convenient remote control for your iPod/MP3 music player. Please refer to the Poly-Planar SpaTunes™ Audio System & iPod/MP3 Controller Owner's Manual.

QUIET SOAK

Pressing the QUIET SOAK pad will turn off all pump operation. This is a useful feature when you want to soak in the hot water with no jets running. The QUIET SOAK feature will last 60 minutes and then resume normal operation. Pressing any of the jet pads will override the QUIET SOAK feature and turn on the

pumps. Or you can simply press the QUIET SOAK pad to exit the mode. Turning the LED lights on and off will not affect the QUIET SOAK mode. The yellow LED indicator by the QUIET SOAK pad will illuminate anytime this feature is engaged. Note: If the system is heating it will take a few moments for the quiet soak feature to engage.

TEMPERATURE DISPLAY AND ADJUSTMENT

Factory Default Settings:

- Temperature: 38°C

To adjust the temperature of the water, press either the TEMP + or TEMP – pad. The display always shows actual water temperature. The first press of the pad will display the set temperature and begin to flash. Continue to press the TEMP + or TEMP – to reach the desired set temperature. Once the display stops blinking the new temperature setting will be set. The factory default setting is 38°C. The minimum temperature that can be set is 27°C and the maximum temperature that can be set is 40°C.

HEAT LIGHT

The HEAT light illuminates when the heater is on. The pump circulates on low-speed whenever the thermostat calls for heat.

HEAT MODE

Your spa comes preset in the standard heat mode. The heat mode can be adjusted to one of three different settings.

MODE

To change the mode of operation, press the MODE pad to begin. Pressing the MODE pad will show the current setting which will begin flashing in the panel display. To change, press the TEMP – pad to scroll through the selections of Std, Ecn, and Slp. Once the desired mode is showing in the display press MODE pad.

Standard Mode (Std)

The spa water heats to the temperature as set on the bather's panel. In this mode the filtration pump turns on for two minutes every half-hour to "poll" or check the water. If heat is needed the unit heats to the set temperature. The LCD window steadily displays the actual temperature in this mode.

Economy Mode (Ecn)

In this mode the spa only heats to the set temperature during a filter cycle. The LCD window displays "Ec" alternately flashing with the actual temperature when the spa is up to temperature and "Ec" steadily when the spa's water temperature is below the set temperature.

Sleep Mode (Slp)

Your spa will maintain a water temperature that is 7°C below the set temperature. The heater functions only during a filter cycle. The LCD window displays "SL" flashing alternately with the actual temperature when the spa is up to set temperature. It displays "SL" steadily when below set temperature.

SMARTCLEAN™ FILTRATION

Your spa is preset at the factory with a default setting to filter itself using the jet pump on low-speed for two hours (F2) twice (dn) in a 24 hour period. These settings represent the filter settings necessary for average use. The timing of the first filter cycle is determined by when the spa was initially energized. The first cycle begins six minutes after this initial power-up. The second filter cycle begins 12 hours after the first cycle.

Factory Default Settings:

- Filter Cycle Duration: F2 (2 hours)
- Filter Cycles: 2C (twice per day)

To adjust the filter settings

Press the TEMP + or TEMP – pad followed by the JETS 1 pad. This will change the display to show the current filtration duration setting. Choices will be given in the display as F1 through F12. "F" refers to filtration and 1-12 represent the duration of the cycle in hours. Use the TEMP + or TEMP – pad to scroll through the choices. Once the desired time is reached, press the JETS 1 pad to save and move to the next setting selection.

The next setting selection will be periods per day that the spa will run. This will allow you to control when the spa will run a filtration cycle. The display will show

"dn" for day and night, "d" for day, or "n" for night. Use the TEMP + or TEMP- pad to scroll through the choices.

Once the desired time is reached, press the JETS 1 pad to save and display the current heat mode setting. The display will automatically revert to the current water temperature. Note: The display will flash during this procedure and will continue to allow changes to be made. If the display stops flashing, go back and start the sequence over.

Selectable filter cycles and cycle duration

- dn: day and night (once every 12 hours)
- d: once during the day
- n: once during the night
- F1: 1 hour
- F2: 2 hours
- Extend to F12 in 1 hour increments

SMARTCLEAN™

Your spa is preset at the factory with a default setting to filter for one hour every time your spa is used. This SmartClean™ filtration cycle begins 30 minutes after the spa light or jet pump has been deactivated. The pump runs on low-speed to filter the water for the cycle's duration.

Standby mode

Standby mode is an effective choice when changing a filter or cleaning around the waterline. To initiate the spa into standby mode, press either the TEMP + or TEMP - pad followed by the JETS 2 pad. The panel display will change to "sby" and the spa will shut all functions down. It will stay in this mode for 60 minutes or can be exited by pressing any pad on the panel. Third press of the JETS pad turns jets off for all-quiet mode. Fourth press of the JETS pad turns pump back to low-speed. If the pump is already on low (heating, filter cycle) then the first press starts the soak timer. After running on low- or high-speed for 15 minutes, the pump automatically turns off (unless in heating or filtering cycle).

SPA CONTROL OPERATION

Show



Epic



PUMP PRIMING (Pr)

Pump priming feature begins at start-up. When your spa is energized, the LCD window displays a "Pr" message. This mode lasts approximately four to five minutes, if not exited manually by pressing the TEMP+ pad.

UNDERWATER AQUA AMBIANCE™, ENTRYWAY LED LIGHTS AND CONSTELLATION™

Press the LIGHTS pad on the bather's panel or remote control (option) to turn the underwater and Entryway lights on and off. The icon appears in the lower center of the display when the light is on. For Constellation, press LIGHTS pad to turn on step one color. To change colors, press LIGHTS pad again to turn off for one second. Then press LIGHTS pad again for step two color. Repeat for all color options. After being on for 60 minutes, the lights automatically turn off. See SETTINGS for automatic light programming.

TRAY FEATURE

The Epic's waterfall feature and convenience tray attaches securely to the dual Vortex skimmer tops. **NOTE:** Don't remove the waterfall top while the pumps are running. The tray feature on the Show spa attaches to the spa interior.

SOAK TIMER

The soak timer starts the first time you press the TIMER pad. The LCD window displays "E" for the elapsed time followed by time in minutes ("00, 01, 02", etc.). A second press of the TIMER pad will exit the timer mode. The timer display and the current temperature display will alternate every 10 seconds.

SETTINGS

Clock

Press the CLOCK pad followed by the SETTING pad. "Program" will be shown in the upper left corner of the panel display and the hour will begin flashing. To adjust, press the TEMP+ or TEMP- pad. Once the correct hour has been set, press SETTING pad to set the minutes. "Minutes" will flash. Follow above procedure to set the correct minutes.

Filter Cycle 1:

Press the CLOCK pad followed by the SETTING pad three times to enter Filter 1 programming. "Program filter 1 start time" will be shown in the upper left corner of the panel display and the hour will begin flashing. To adjust, press the TEMP+ or TEMP- pads. Once the correct hour has been set, press SETTING pad to set the minutes. Follow above procedure to set the correct minutes. Press the SETTING pad again and "Program filter 1 end time" will be shown in the upper left corner of the panel display and the hour will begin flashing. Follow above procedures to set the correct hour and minutes.

NOTE: When in a filter cycle, the Filter Cycle LED will illuminate.

Filter Cycle 2:

Press SETTING pad to enter filter 2 programming mode. "Program Filter 2 start time" will be shown in the upper left hand corner of the panel display and the hour will begin flashing. Follow above procedure to set the correct hour and minutes. Press the SETTING pad again and "Program filter 2 end time" will be shown in the upper left corner of the panel display. Follow above procedure to set correct hour and minutes.

Spa Light:

Press SETTING pad to enter spa light programming mode. The light icon will begin flashing at the bottom of the panel display. "Start time" will be shown in the upper left hand corner of the panel display and the hour will begin flashing. Follow above procedure to set the correct hour and minutes. Press the SETTING pad again and "end time" will be shown in the upper left corner of the panel display and the hour will begin flashing. Follow above procedure to set the correct hour and minutes. Press the CLOCK pad to exit the programming mode. **NOTE:** Any time during the setting of features, you may exit the programming mode by pressing the CLOCK pad. If you do not want to run the spa light cycles, set the start and end times for the same time.

HEAT MODE

Your spa comes preset in the Standard heat mode. Allow about one hour per 0.56°C for heating your spa water when increasing the temperature to the desired level. The heat mode can be adjusted to one of three different settings:

Standard Mode

The spa water heats as necessary to maintain the set temperature. "Standard" will display until the mode is changed.

NOTE: The last measured temperature displayed is current only when Pump 1 has been running for at least two minutes.

Economy Mode

In this mode the spa only heats to the set temperature during a filter cycle. The "Economy" icon will display until the mode is changed. Press the JETS 1 pad to put the spa in "Standard-in-Economy" mode which operates the same as Standard mode (both Economy and Standard will display). The spa reverts to Economy mode automatically after one hour.

Sleep Mode

The spa water heats to within 7°C of the set temperature only during filter cycles. "Sleep" will display until the mode is changed.

To Adjust Heat Mode

First press the SETTINGS pad. The current heat mode will start flashing. Use the TEMP- pad to scroll through the modes. When desired mode is displayed, touch the SETTINGS pad again to lock the mode.

Panel Lock

Press TEMP+ or TEMP- pad followed by QUIET SOAK pad to lock. Then press TEMP+ or TEMP- pad followed by QUIET SOAK pad to unlock.

- Lock feature locks all user settings: time, filter cycles, heat modes, SmartClean™ and temperature settings.
- Lock feature **does not** lock Jets 1, Jets 2, Timer, Spa Light, Quiet Soak, or Clock.
- Secured LED will illuminate when system is locked.

CONSTANTCLEAN™ WATER MANAGEMENT WITH BUILT-IN SANITATION SYSTEM

Not available in all markets. (See Built-in Sanitation System)

Ozonator Operation

The ozone generator operates when pump 1 is on low-speed in Filter Cycles and SmartClean™ cycles ONLY. The O3 icon appears to the left of the temperature display when the ozone generator is operating.

User Preference Settings

Suppress reminders: Displayed as (Sr.n) for no, and (Sr.Y) for yes. When set to (Sr.Y), reminders are never shown in the display. When set to (Sr.n), all reminders are shown.

Temperature display in Celsius: Displayed as (tc.n) for no, and (tc.Y) for yes.

24 hour time: Displayed as (24.n) for no (12 hour AM/PM), and (24.Y) for yes (24 hour military).

SmartClean™ settings: Displayed as (cc.0) for SmartClean off, (cc.1) 1 hour, (cc.2) 2 hour, (cc.3) 3 hour, and (cc.4) for 4 hour Smart Logic durations. When the spa is in a SmartClean cycle, the SmartClean LED will illuminate.

To Enter the User Preference Mode

- Press the TEMP+ button
- Press the JETS 1 button (displays (Edit))
- Press the LIGHTS button (displays (USr))
- Press the JETS 1 button (displays (Sr.n))
- Use TEMP + or TEMP- pad to scroll through options
- Sr.n: Reminders not suppressed
- tc.n: Temperature display not in Celsius
- 24.n: 12 hour AM/PM
- cc.1: One hour Smart Logic
- Once the desired selection has been reached, press the JETS 1 pad. The last number or letter will flash. Use the TEMP + or TEMP- pad to change the setting. Press the JETS 1 pad to enter selection and return to previous mode.
- Press the LIGHTS pad twice to return to normal operation.
- At any point, if a pad is not pressed within thirty seconds of a previous pad press, the mode will cancel and the spa will return to normal operation.

To Change the Set Temperature

Factory default temperature setting: 100°F (38°C). The LCD window displays the actual water temperature. Press the TEMP+ or the TEMP- pad. Each pad press changes the set temperature by one degree. Temperature can be set between 80°F and 104°F (26°C and 40°C). When the spa is heating the Heat icon will be shown in the lower right corner of display.

Quiet Soak

Press the QUIET SOAK pad to enter the soak mode. All automatic functions related to the pumps are disabled (i.e., filter cycles, SmartClean™ cycles). If either pump 1 or pump 2 are operating, they will be turned off. Soak mode lasts for 30 minutes, then the spa returns to normal operation. All button functions operate as normal while in a Soak mode. When in a Soak mode, the Soak LED will illuminate.

Maintenance Reminders

- rSA will be displayed in the LCD window every 21 days.
- Clean Filter LED will illuminate every 30 days. rCL will be displayed in the LCD window.

- Change Water LED will illuminate every 90 days. rCH will be displayed in the LCD window.
- rCA will be displayed in the LCD window every 90 days (see LCD Diagnostic Messages).
- To reset maintenance reminders, press SETTINGS pad. (See USER PREFERENCE SETTINGS to suppress maintenance reminders.)

JETS

Use JETS 1 pad on either bather's panel or remote control. First press JETS 1 pad to activate pump on low-speed. Second press of JETS 1 pad activates pump on high-speed. Third press of JETS 1 pad turns jets off for all-quiet soak setting. Fourth press of JETS 1 pad returns pump to low-speed. Repeat above procedure for JETS 2 and JETS 3.

Pump 1, 2 and 3: Epic (2 pumps) and Show (3 pumps)

- High-speed run timeout: 15 minutes
- Low-speed run timeout: 15 minutes (if not in filter cycle or SmartClean™).

WISH AUXILIARY LOUNGE CONTROL

Auxiliary panel controls the jets and lights. (See SPA CONTROL OPERATION in the Owner's Manual.)

REMOTE CONTROLS

(See OPERATING YOUR SPA, Light, and Jets.)

NOTE: During times of inactivity, wireless remotes should always be stored in the cup holder on the lip of the spa or removed from the spa. By storing the wireless remote out of water, the remote will be less susceptible to water intrusion, a situation that can occur after extended water exposure. More often, water intrusion occurs when spa owners attempt to replace the batteries in their remote and then do not properly reseal the remote. Battery replacement should only be performed by authorized Marquis Spas® dealer.

ADAGIO™ AUDIO SYSTEMS

Stereo

The audio system is easy to operate with logical push button controls and function keys. Please refer to the manufacturer's owner's manual for features, operation, and troubleshooting.

NOTE: Avoid water splashing on the stereo face. Never insert a disk or operate the stereo with wet hands. Moisture can damage internal components. Water intrusion into stereo is not covered under warranty. See manufacturer's owner's manual for coverage information. Consult your Limited Warranty for more information about coverage.

Speakers

Gently push the top of the self-rising speakers to raise them. Hold the speaker top, avoiding the speaker screens, and gradually rotate the speakers as desired. To lower the speakers gently push the speaker top until it is completely closed. Make sure speakers are in the down position before closing the spa cover. Speaker lift mechanism is manufacturer-warranted against failure to lift due to manufacturing defects only. Closing the spa cover with speakers in the up position or forcing the speaker down too rapidly can result in damage.

- **CAUTION** - Risk of Electric Shock. Do not leave compartment door open.
- **CAUTION** - Risk of Electric Shock. Replace components only with identical components.
- Do not operate the audio controls while inside the spa.
- **WARNING** – Prevent Electrocution. Do not connect any auxiliary components (for example, cable, additional speakers, headphones, additional audio/video components, etc.) to the system, except as provided by the following: The 3.5 mm auxiliary jack is designed for input only from devices such as an MP3 player operating at 4.5 V or less.
- These units are not provided with an outdoor antennae; it should be installed in accordance with Article 810 of the National Electrical Code, ANSI/NFPA 70.
- Do not service this product yourself as opening or removing covers may expose you to dangerous voltage or other risk of injury. Refer all servicing to qualified service personnel.
- If the power supply connections or power supply cord(s) are damaged; if water is entering the audio compartment or any electrical equipment compartment area; if the protective shields or barriers are showing signs of deterioration; or if there are signs of other potential damage to the unit, turn off the unit and refer servicing to a qualified service personnel.
- This unit should be subjected to periodic routine maintenance (for example, once every three months) to make sure that the unit is operating properly.

Audio Expansion Port

The built-in audio expansion port allows you to connect optional accessories. Use the supplied 3.5 cm cord to attach MP3 player. **NOTE:** The 3.5 cm auxiliary jack is designed for input only from devices such as an MP3 player operating at 4.5V or less.

ADAGIO™ II AUDIO SYSTEM (OPTION)

Adagio™ II provides a safe enclosure and convenient remote control for your iPod music player. Please refer to the Poly-Planar SpaTunes™ Audio System & iPod Controller Owner's Manual.

AQUAVISION MONITOR (OPTION ON SHOW)

Aquavision is a completely independent waterproof video monitor that is built to the latest regulations in waterproofing and safety, it is designed to integrate into your spa environment. Aquavision incorporates the latest state of the art screens with the latest and best features. Aquavision features heated screen areas to prevent the front from misting up in humid conditions or even freezing up in cold conditions. The E-Suite™ features an Aquavision unit with Adagio™ audio system and a wireless remote control.

Operating the Monitor

Gently push the PRESS button on top of the self-rising monitor unit to raise it. To lower the monitor unit, gently push the PRESS button. Make sure monitor unit is in the down position before closing the spa cover. Monitor lift mechanism is manufacturer-warranted against failure to lift due to manufacturing defects only. Closing the spa cover with monitor in the up position or forcing the monitor down too rapidly can result in damage. Please refer to the Aquavision manufacturer's owner's manual for features, operation, and troubleshooting.

EQUIPMENT DIAGRAMS

ENVY, MIRAGE, PROMISE, RENDEZVOUS, SPIRIT

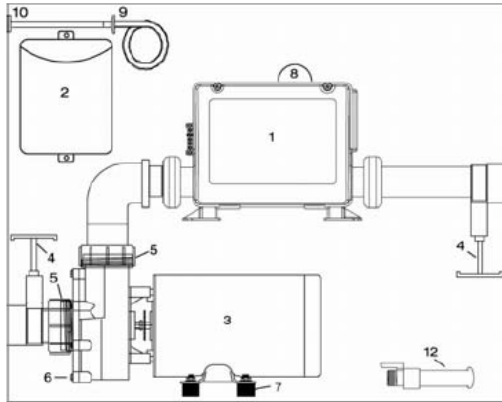

#	Component	Quantity
1	Control Box and Heater	1
2	Ozonator*	1
3	Pump	1
4	Slice Valves	2
5	Pump Unions	2
6	Pump Plug	1
7	Motor Mounts	4
8	Light	1
9	Check Valve	1
10	Ozonator Fitting*	1
12	Drain Valve	1
14	Adagio™ Stereo Head*	1
15	Cross Over Control*	1
16	Spa Control*	1
17	MP3 Auxiliary Jack*	1
18	Stereo Power Supply*	1

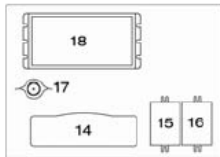

*Optional

WISH

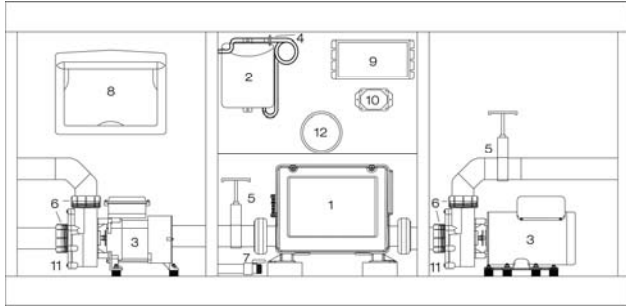

#	Component	Quantity
1	Control Box and Heater	1
2	Ozonator (option)	1
3	Pumps	2
4	Check Valve (option)	1
5	Slice Valves	2
6	Pump Unions	4
7	Drain Valve	1
8	Adagio™ Stereo Head (option)	1
9	Stereo Power Supply (option)	1
10	Constellation™ LED Control (option)	1
11	Pump Plugs	2
12	Light	1

DESTINY, EPIC, RESORT AND REWARD

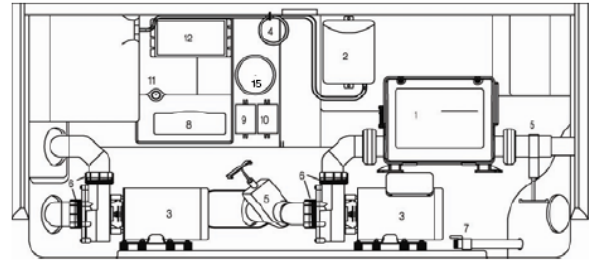

#	Component	Quantity
1	Control Box and Heater	1
2	Ozonator*	1
3	Pumps	2
4	Check Valve*	1
5	Slice Valves	2
6	Pump Unions	4
7	Drain Valve	1
8	Adagio™ Stereo Head*	1
9	Cross Over Control*	1
10	Spa Control*	1
11	MP3 Auxiliary Jack*	1
12	Stereo Power Supply*	2
14	Ozonator Fitting	1
15	Light*	1
16	Constellation™ LED Control*	1

SHOW

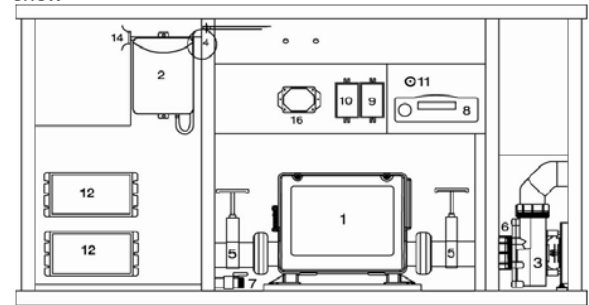

1	Control Box and Heater	1
2	Ozonator (option)	1
3	Pumps***	3
4	Check Valve*	1
5	Slice Valves	2
6	Pump Unions	4
7	Drain Valve	1
8	Adagio™ Stereo Head*	1
9	Cross Over Control*	1
10	Spa Control*	1
11	MP3 Auxiliary Jack*	1
12	Stereo Power Supply*	2
14	Ozonator Fitting	1
16	Constellation™ LED Control*	1

* Optional

***For Show auxiliary pumps locations see SHOW MODEL DIAGRAM

EUPHORIA

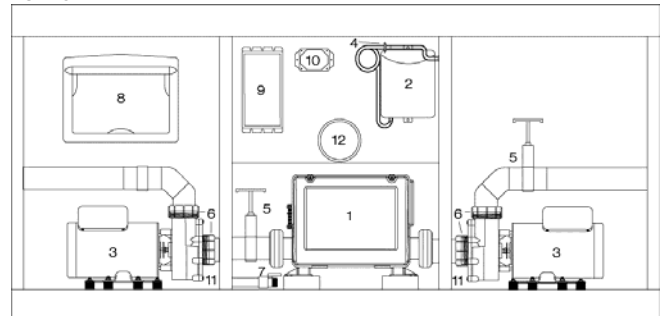

DESTINY™

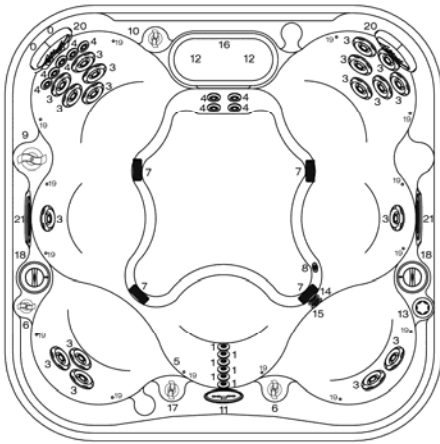

#	Component Identification	Quantity	Physical Specifications	Size
0	HK™8 Neck Jets	2	Dimensions/mm	2134 x 2134
1	HK™8 Jets	6	Height/mm	889
3	HK™16 Jets	18	Corner Radius/mm	432
4	HK™40 Jets	9	Seating Positions	7
5	Light*	1	Weight Dry/Kgs.	363
6	Air Controls	2	Weight Full/Kgs.	1762
7	Suction Fittings	4	Water Capacity/Litres	1401
8	Floor Drain	1	Total Therapy Jets	35
9	Tri-Zone Control	1		
10	Neck Jet Valve	1		
11	Bather's Control Panel	1		
12	Filter Canisters	2		
13	Spa Frog®*	1		
14	Spa Frog® Return Fitting*	1		
15	Ozone Injector Fitting*	1		
16	Waterfall Feature*	1		
17	Waterfall Valve*	1		
18	Adagio™ Speakers	2		
19	Constellation*	16		
20	Cushioned Headrests*	2		
21	Water Features*	2		

ENVY™

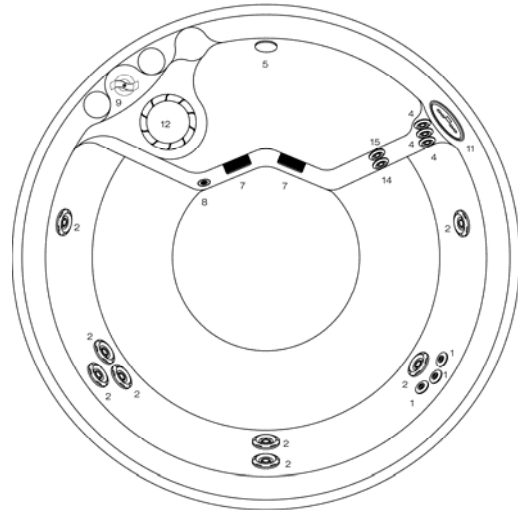

#	Component Identification	Quantity	Physical Specifications	Size
1	HK™8 Jets	3	Dimensions/mm	1930
2	HK™12 Jets	8	Height/mm	889
4	HK™40 Jets	3	Seating Capacity/Positions	4/5
5	Light*	1	Weight Dry/Kgs.	249
7	Suction Fittings	2	Weight Full/Kgs.	1195
8	Drain Fitting	1	Water Capacity/Litres	946
9	Jet Selector	1	Total Therapy Jets	14
11	Bather's Control Panel	1		
12	Filter Canister	1		
15	Ozone-ready Injector Fitting* ¹	1		
16	Power Supply	1		

*Items are optional. Check with dealer for availability.

**HK™8 Neck Jets operate in every zone.

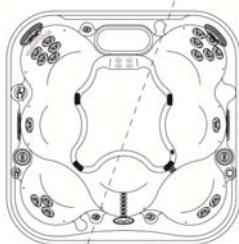

Destiny Tri-Zone Control

ZONE 1 (Jets 1)
Mid- and lower-back jets.*

ZONE 4 (Jets 2)
Upper- and mid- and lower-body jets.*

JETS 1 JETS 2



ZONE 2 (Jets 1)
Upper-body jets.*

ZONE 5 (Jets 2)
Upper- and mid- and lower-body jets.*

JETS 1 JETS 2



ZONE 3 (Jets 1)
Lower-body jets.*

ZONE 6 (Jets 2)
Upper-, mid, and lower-body jets.*

*Items are optional. Check with dealer for availability.

**HK™8 jets operate in every zone.

JETS 1 JETS 2

EPIC™

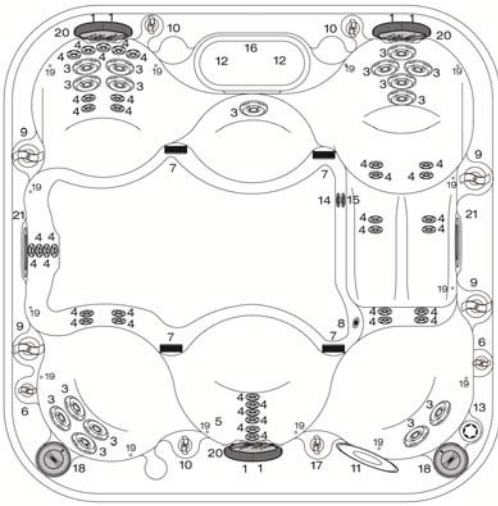

#	Component Identification	Quantity
1	HK™ 8 Neck Jets	6
2	HK™ 16 Jets	16
3	HK™ 40 Jets	35
5	Light*	1
6	Air Controls	2
7	Suction Fittings	4
8	Floor Drain	1
9	Tri-Zone Control	4
10	Neck Jet Valves	3
11	Bather's Control Panel	1
12	Filter Canisters	2
13	Spa Frog®*	1
14	Spa Frog® Return Fitting*	1
15	Ozone Injector Fitting*	1
16	Waterfall Feature*	1
17	Waterfall Valve*	1
18	Adagio™ Speakers	2
19	Constellation*	17
20	Cushioned Headrests*	3
21	Water Features*	2

Physical Specifications	Size
Dimensions/mm	2286 x 2286
Height/mm	889
Interior Depth/mm	864
Corner Radius/mm	432
Seating Positions	7
Weight Dry/Kgs.	386
Weight Full/Kgs.	2088
Water Capacity/Litres	1703
Total Therapy Jets	57

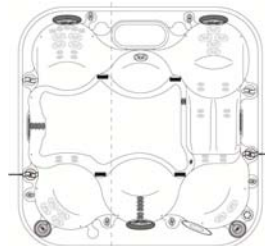

Epic Tri-Zone Control

A (JETS 2)
Tri-Zone A in position 1: Therapy Pillar.**

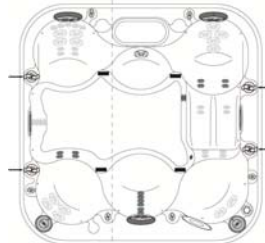

B (JETS 1)
Tri-Zone B in position 3: Full back.**

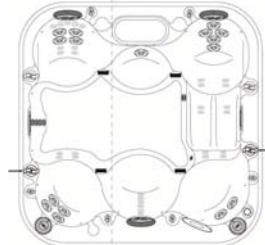

A+C (JETS 2)
Tri-Zone A in position 3 and Tri-Zone C in position 1: Feet.**

B+D (JETS 1)
Tri-Zone B in position 1 and Tri-Zone D in position 3: Thighs.**

*Items are optional. Check with dealer for availability.
**HK™ 8 jets operate in every zone.

EUPHORIA™

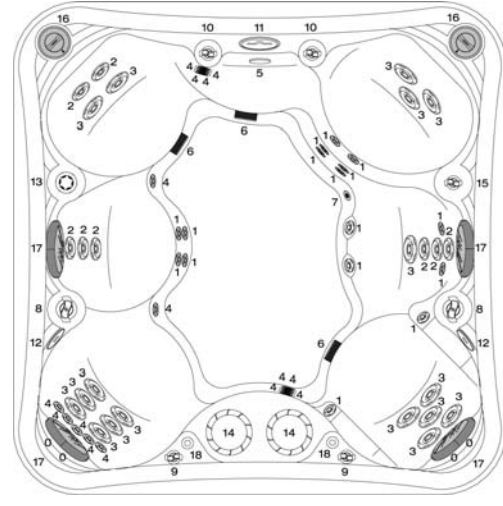

#	Component Identification	Quantity
0	HK™ 8 Neck Jets	4
1	HK™ 8 Jets	18
2	HK™ 12 Jets	8
3	HK™ 16 Jets	17
4	HK™ 40 Jets	13
5	Light*	1
6	Suction Fittings	3
7	Floor Drain	1
8	Jet Selector	2
9	Neck Jet Valve	2
10	Air Controls	2
11	Bather's Control Panel	1
12	Auxiliary Control	2
13	Spa Frog®*	1
14	Filter Canisters	2
15	Waterfall Valve*	1
16	Adagio™ Speakers	2
17	Cushioned Headrests*	4
18	Water Features*	2

Physical Specifications	Size
Dimensions/mm	2286 x 2286
Height/mm	864
Corner Radius/mm	305
Seating Capacity/Positions	7
Weight Dry/Kgs.	374
Weight Full/Kgs.	1887
Water Capacity/Litres	1514
Total Therapy Jets	58

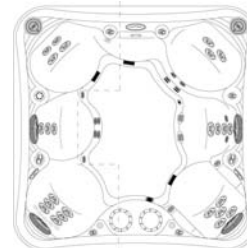

Euphoria Tri-Zone Control

ZONE 1 (JETS 1)
Mid- and lower-back jets.**

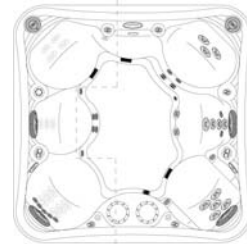

ZONE 1 (JETS 2)
Upper-back jets.**



ZONE 1 (JETS 3)
Whirlpool jets.**

MIRAGE™



Euphoria Tri-Zone Control

ZONE 2 (JETS 1)
Leg, wrist, upper- and mid-back jets.*

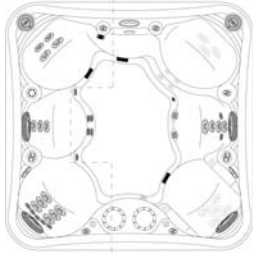

ZONE 2 (JETS2)
Leg, upper-, mid- and lower-back jets.**



ZONE 2 (JETS 3)
Whirlpool jets.**

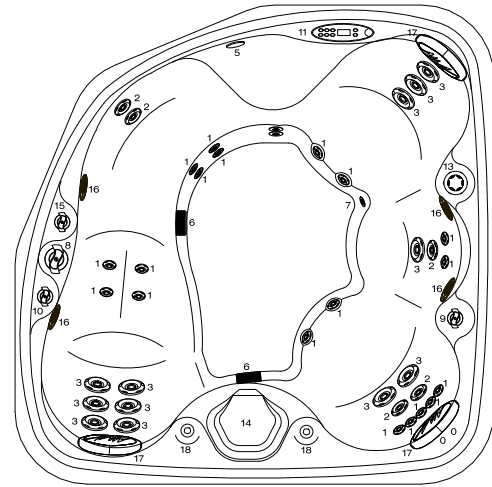

#	Component Identification	Quantity
0	HK™8 Neck Jets	2
1	HK™8 Jets	19
2	HK™12 Jets	5
3	HK™16 Jets	12
5	Light*	1
6	Suction Fittings	2
7	Floor Drain	1
8	Jet Selector	1
9	Neck Jet Valve	1
10	Air Control	1
11	Bather's Control Panel	1
12	Spa Frog®*	1
13	Spa Frog® Return Fitting*	1
14	Filter Canister	1
15	Ozone Injector Fitting*	1
16	Waterfall Feature*	1
20	Cushioned Headrests*	3
21	Adagio™ Speakers	4
22	Water Feature*	2

Physical Specifications	Size
Dimensions/mm	2066 x 2066
Height/mm	864
Corner Radius/mm	432
Seating Capacity/Positions	4/5
Weight Dry/Kgs.	204
Weight Full/Kgs.	1207
Water Capacity/Litres	1003
Total Therapy Jets	38

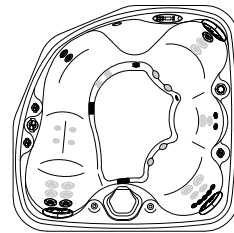

Mirage Zone Control

ZONE 1A
Upper-back jets.**

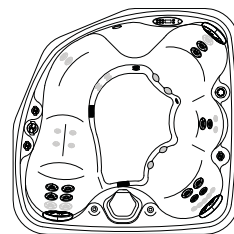

ZONE 1B
Mid- and lower-back jets.**

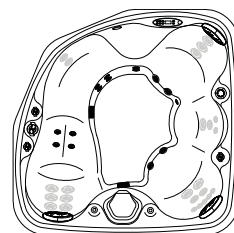

ZONE 1C
Leg and foot jets.**

*Items are optional. Check with dealer for availability.
**HK™8 Neck Jets operate in every zone.

PROMISE™

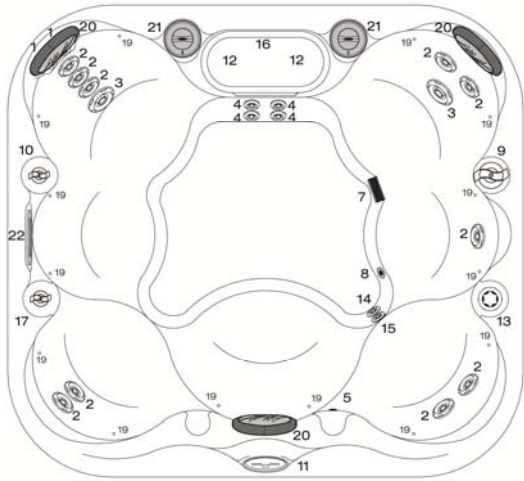

#	Component Identification	Quantity	Physical Specifications	Size
1	HK™ 8 Neck Jets	2	Dimensions/mm	1956 x 2134
2	HK™ 12 Jets	10	Height/mm	864
3	HK™ 16 Jets	2	Corner Radius/mm	432
4	HK™ 40 Jets	4	Seating Positions	4-6
5	Light*	1	Weight Dry/Kgs.	272
7	Suction Fittings	4	Weight Full/Kgs.	1559
8	Floor Drain	1	Water Capacity/Litres	1287
9	Jet Selector	1	Total Therapy Jets	18
10	Neck Jet Valve	1		
11	Bather's Control Panel	1		
12	Filter Canisters	2		
13	Spa Frog®*	1		
14	Spa Frog® Return Fitting*	1		
15	Ozone Injector Fitting*	1		
16	Waterfall Feature*	1		
17	Waterfall Valve*	1		
19	Constellation*	17		
20	Cushioned Headrests*	3		
21	Adagio™ Speakers	2		
22	Water Features*	1		

RENDEZVOUS™

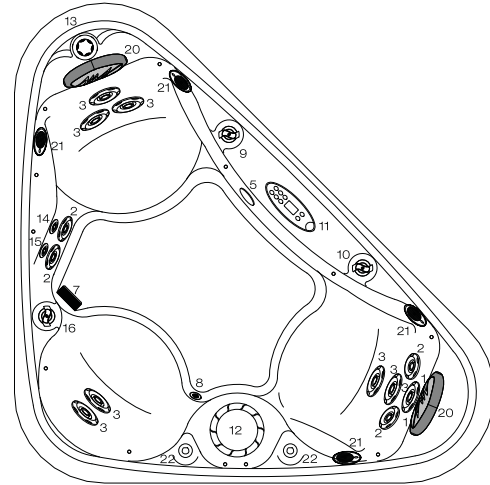

#	Component Identification	Quantity	Physical Specifications	Size
1	HK™ 8 Neck Jets	2	Dimensions/mm	1900 x 1900
2	HK™ 12 Jets	4	Height/mm	760
3	HK™ 16 Jets	8	Corner Radius/mm	432
5	Light*	1	Seating Positions	3
7	Suction Fittings	2	Water Capacity/Litres	644
8	Floor Drain	1	Total Therapy Jets	14
9	Air Control	1		
10	Neck Jet Valve	1		
11	Bather's Control Panel	1		
12	Filter Canister	1		
13	Spa Frog®*	1		
14	Spa Frog® Return Fitting*	1		
15	Ozone Injector Fitting*	1		
20	Cushioned Headrests*	2		
21	Adagio™ Speakers	4		
22	Water Feature*	1		



Promise Zone Control

ZONE 1
Lower-body jets.**



ZONE 2
Upper-, mid- and lower-back jets.**

RESORT™

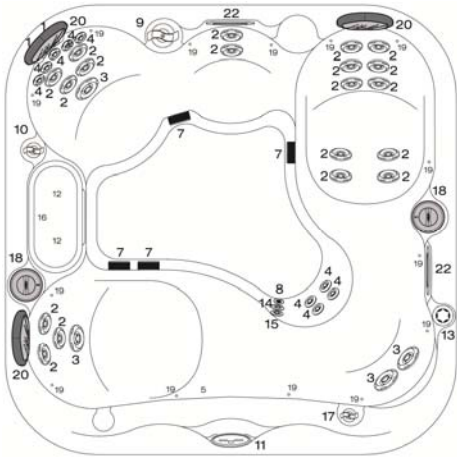

#	Component Identification	Quantity	Physical Specifications	Size
1	HK™8 Neck Jets	2	Dimensions/mm	2134 x 2134
2	HK™12 Jets	19	Height/mm	864
3	HK™16 Jets	4	Corner Radius/mm	432
4	HK™40 Jets	9	Seating Positions	5
5	Light*	1	Weight Dry/Kgs.	327
7	Suction Fittings	4	Weight Full/Kgs.	1651
8	Floor Drain	1	Water Capacity/Litres	1325
9	Jet Selector	1	Total Therapy Jets	34
10	Neck Jet Valve	1		
11	Bather's Control Panel	1		
12	Filter Canisters	2		
13	Spa Frog®	1		
14	Spa Frog® Return Fitting*	1		
15	Ozone Injector Fitting*	1		
16	Waterfall Feature*	1		
17	Waterfall Valve*	1		
18	Adagio™ Speakers*	2		
19	Constellation*	17		
20	Cushioned Headrests*	3		
22	Water Feature*	1		

REWARD™

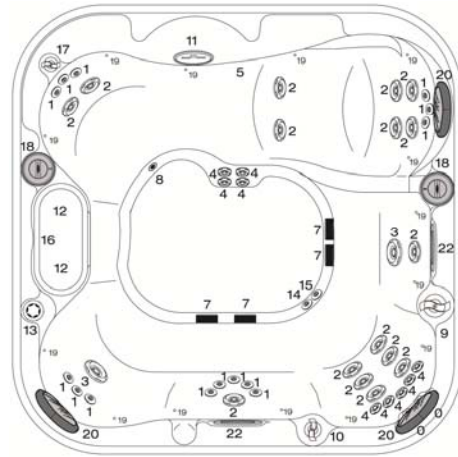

#	Component Identification	Quantity	Physical Specifications	Size
0	HK™8 Neck Jets	2	Dimensions/mm	2134 x 2134
1	HK™8 Jets	14	Height/mm	864
2	HK™12 Jets	16	Corner Radius/mm	432
3	HK™16 Jets	9	Seating Capacity/Positions	6
4	HK™40 Jets	4	Weight Dry/Kgs.	336
5	Light*	1	Weight Full/Kgs.	1660
7	Suction Fittings	4	Water Capacity/Litres	1325
8	Floor Drain	1	Total Therapy Jets	43
9	Jet Selector	1		
10	Neck Jet Valve	1		
11	Bather's Control Panel	1		
12	Filter Canisters	2		
13	Spa Frog®	1		
14	Spa Frog® Return Fitting*	1		
15	Ozone Injector Fitting*	1		
16	Waterfall Feature*	1		
17	Waterfall Valve*	1		
18	Adagio™ Speakers	2		
19	Constellation*	17		
20	Cushioned Headrests*	3		
22	Water Features*	2		



Resort Zone Control

ZONE 1 (JETS 1)

Upper-, mid- and lower-back jets.**

ZONE 1 (JETS 2)

Upper-, mid- and lower-back jets.**

ZONE 2 (JETS 1)

Upper-back jets.**
Mid-, lower-back and leg jets.**

ZONE 3 (JETS 1)

Lower-body jets.**

*HK™8 Neck Jets operate in Zone 2 (Resort)

**Items are optional. Check with dealer for availability.

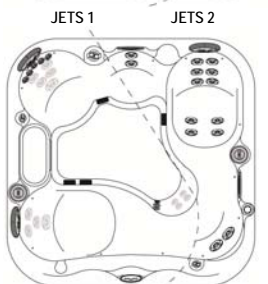

Reward Zone Control

ZONE 1 (JETS 2)

Upper-, mid- back, and leg jets.**

ZONE 1 (JETS 1)

Upper-, mid- back, and leg jets.**

ZONE 2 (JETS 1)

Upper- back jets.**

ZONE 3 (JETS 1)

Lower- body jets.**

*Items are optional. Check with dealer for availability.
**HK™8 Neck Jets operate in every zone.

SHOW™

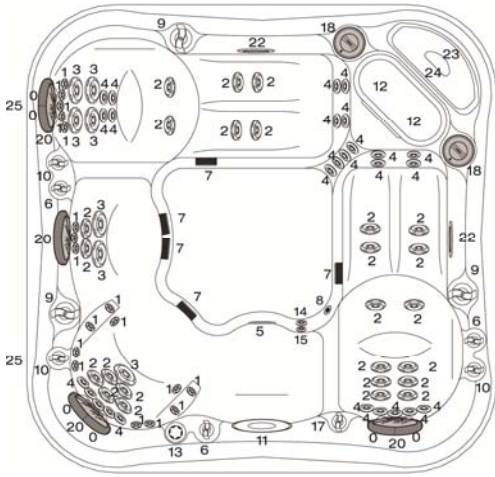

#	Component Identification	Quantity
0	HK™8 Neck Jets	6
1	HK™8 Jets	18
2	HK™12 Jets	25
3	HK™16 Jets	7
4	HK™40 Jets	26
5	Light*	1
6	Air Controls	3
7	Suction Fittings	4
8	Floor Drain	1
9	Jet Selectors	3
10	Neck Jet Valves	3
11	Bather's Control Panel	1
12	Filter Canisters	2
13	Spa Frog®	1
14	Spa Frog® Return Fitting*	1
15	Ozone Injector Fitting*	1
17	Waterfall Valve*	1
18	Adagio™ Speakers*	2
19	Constellation™	16
20	Cushioned Headrests*	4
22	Water Features*	2
23	Cooler	1
24	TV*	1
25	Pump Interior Locations	2

Physical Specifications	Size
Dimensions/mm	2286 x 2390
Height/mm	889
Corner Radius/mm	432
Seating Positions	5
Weight Dry/Kgs.	499
Weight Full/Kgs.	2296
Water Capacity/Litres	1798
Total Therapy Jets	82



Show Tri-Zone Control

ZONE 4 (JETS 1)
Adirondack A: upper-back..**



ZONE 5 (JETS 2)
Adirondack B: lower-back..**

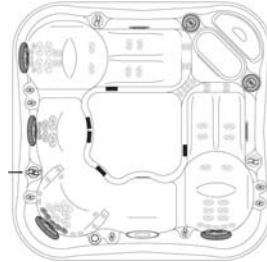

ZONE 6 (JETS 3)
Captain's Chair: lower-back..**



ZONE 7 (JETS 1)
Adirondack A: feet..**

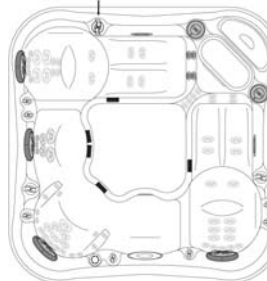

ZONE 8 (JETS 2)
Adirondack B: feet..**



ZONE 9 (JETS 3)
Therapy pillar: legs and feet..**



Show Tri-Zone Control

ZONE 1 (JETS 1)
Adirondack A: all back, hips, legs and feet.**

ZONE 2 (JETS 2)
Adirondack B: upper- and mid-back, hips and feet.**

ZONE 3 (JETS 3)
Captain's Chair: mid- and lower-back, arms, knees and wrists.**
Seat: all back.**

*Items are optional. Check with dealer for availability.
**HK™8 Neck Jets operate in every zone

SPiRiT™

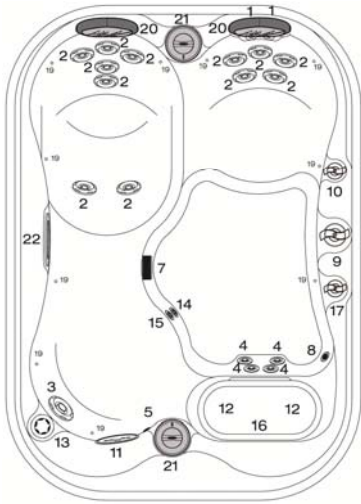

#	Component Identification	Quantity	Physical Specifications	Size
1	HK™ 8 Neck Jets	2	Dimensions/mm	2134 x 1524
2	HK™ 12 Jets	12	Height/mm	749
3	HK™ 16 Jets	1	Corner Radius/mm	432
4	HK™ 40 Jets	4	Seating Capacity/Positions	3/4
5	Light*	1	Weight Dry/Kgs.	186
7	Suction Fitting	1	Weight Full/Kgs.	810
8	Floor Drain	1	Water Capacity/Litres	623
9	Jet Selector	1	Total Therapy Jets	19
10	Neck Jet Valve	1		
11	Bather's Control Panel	1		
12	Filter Canisters	2		
13	Spa Frog®	1		
14	Spa Frog® Return Fitting*	1		
15	Ozone Injector Fitting*	1		
16	Waterfall Feature*	1		
17	Waterfall Valve*	1		
19	Constellation*	12		
20	Cushioned Headrests*	2		
21	Adagio™ Speakers*	2		
22	Water Feature*	1		

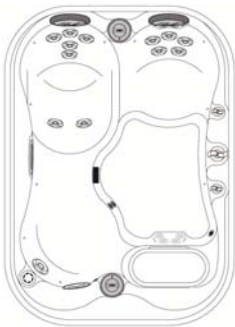

Spirit Zone Control

ZONE 1A
Upper-, mid- and lower-back jets.**

ZONE 1B
Lower- body jets.**

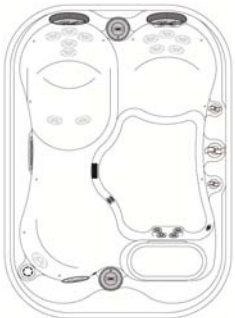

*Items are optional. Check with dealer for availability.
**HK™ 8 Neck Jets operate in every zone.

WiSH™

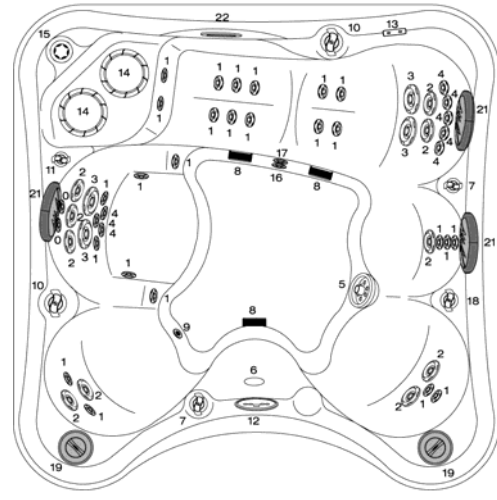

#	Component Identification	Quantity	Physical Specifications	Size
0	HK™ 8 Neck Jets	2	Dimensions/mm	2134 x 2134
1	HK™ 8 Jets	24	Height/mm	889
2	HK™ 12 Jets	10	Corner Radius/mm	305
3	HK™ 16 Jets	4	Seating Capacity/Positions	3/4
4	HK™ 40 Jets	9	Weight Dry/Kgs.	356
5	Geyser Jet	1	Weight Full/Kgs.	1642
6	Light*	1	Water Capacity/Litres	1287
7	Air Controls	2	Total Therapy Jets	50
8	Suction Fittings	3		
9	Floor Drain	1		
10	Jet Selectors	2		
11	Neck Jet Valve	1		
12	Bather's Control Panel	1		
13	Auxiliary Control (Jets/Light)	1		
14	Filter Canisters	2		
15	Spa Frog®	1		
16	Spa Frog® Return Fitting*	1		
17	Ozone Injector Fitting*	1		
18	Waterfall Valve*	1		
19	Adagio™ Speakers*	2		
20	Constellation*	1		
21	Cushioned Headrests*	3		
22	Waterfall Feature*	1		

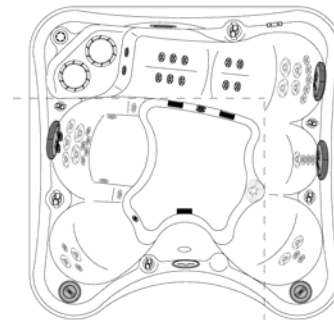

Wish Tri-Zone Control

ZONE 1 (JETS 1)
Lounge leg and foot jets.**

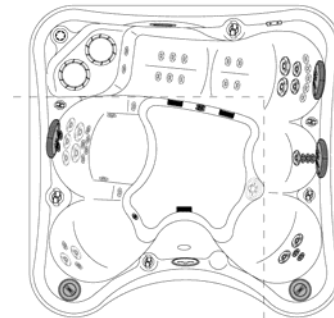

ZONE 1 (JETS 2)
Upper-, mid-, and lower-back jets.**

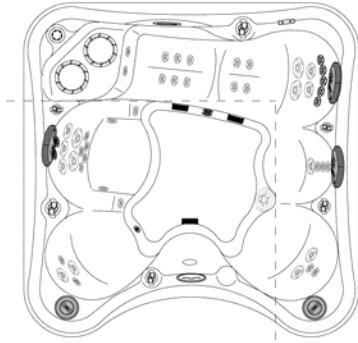

Wish Tri-Zone Control

ZONE 1 (JETS 3)
Lounge upper-back jets**

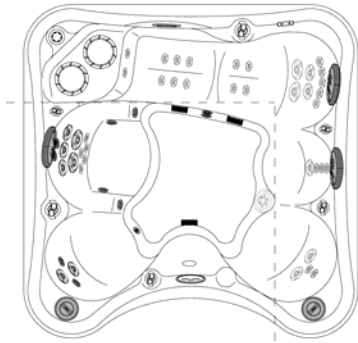

ZONE 2 (JETS1)
Upper- and mid-back jets.**

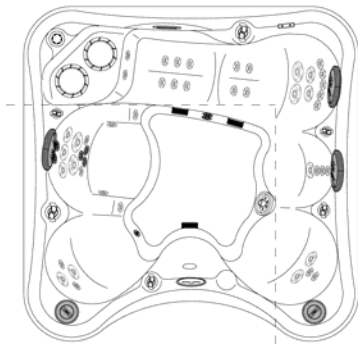

ZONE 2 (JETS2)
Lower-back and Geyser jets**

TROUBLESHOOTING GUIDE

PLEASE NOTE: The following corrective actions may be performed by the spa owner. If the trouble cannot be corrected in the steps below, please contact your authorized Marquis spa dealer for service. (Improper servicing by an unauthorized service provider or spa owner could result in damage not covered by the warranty and could cause serious injury.)

EQUIPMENT WILL NOT OPERATE

- Check the control panel LCD window for diagnostic code.
- Check the circuit breaker on the main circuit panel.
- Check the condition of the power cord.

INADEQUATE JET ACTION

- Be sure the shut-off valves are completely open.
- Open the jets by turning the jet face to allow for maximum water flow.
- Check for obstruction or restrictions at suction guard(s) or filters, such as leaves.
- Check that the water is at proper level, 2/3 up the Vortex skimmer opening(s).
- Inspect the filter cartridge(s) for dirt and debris.

NO HEAT

- Check temperature displayed in the LCD window for desired temperature setting.
- Inspect the filter cartridge(s) for dirt and debris.
- Check that the water is at proper level, 3" above skimmer opening(s).
- Check HEAT MODE to be certain spa is not in SLEEP MODE.
- Lower ambient temperatures may result in heat loss.

NOTE: Do not expect instant hot water from the jets. It will take the heater 12-24 hours to heat the water to the temperature you desire.

LIGHT DOES NOT WORK

- Press the LIGHT pad on the control panel.
- Reposition the light bulb in the socket. (See REPLACING LIGHT BULB.)
- Replace the light bulb with similar component only.

LCD DIAGNOSTIC MESSAGES

The advanced technology built into the spa allows it to perform a number of self-diagnostic system checks and it can display a variety of messages in the LCD window on the control panel.

HH: Over heat protection. The system completely shuts down. In such a condition, **DO NOT ENTER THE WATER**. Contact your dealer for service.

OH: Overheat protection. If a malfunction occurs and the spa water reaches 43°C, the system completely shuts down. In such a condition, **DO NOT ENTER THE WATER**. Turn off all power to the spa and contact your dealer for service. Several conditions could lead to overheating, for example, low water level, shut-off valves closed while heater is on, dirty filter, and restriction in the plumbing lines. After the power is turned back on, the spa will not restart itself until the water temperature within the spa drops to a lower, predetermined temperature. As a double safety feature, a secondary high-limit sensor shuts the system off if the water temperature in the heater housing reaches 118°F (48°C). In this case, the spa may be restarted by pressing any panel pad after the water has cooled to 110°F (42°C). If the switch trips repeatedly, do not use the spa and contact your authorized dealer for service.

IC: Ice. Potential freeze condition detected.

SA: Spa is shut down. Sensor plugged into sensor "A" jack is not working.

Sb: Spa is shut down. Sensor plugged into sensor "B" jack is not working.

Sn: A sensor has malfunctioned. If alternating with spa temperature, it may just be a temporary condition. If flashing by itself, spa is shut down. Contact your dealer for service.

HL: A significant difference between temperature sensors has been detected. This could indicate a flow problem. Check water level in spa and refill if necessary. If water level is okay, make sure the pumps have been primed.

LF: Persistent low flow problems. Heater is shut down, but other spa functions continue to run normally. Check water level and refill if necessary. Contact your dealer for service.

dr: Possible inadequate water, poor flow, or air bubbles detected in the heater. Spa is shut down for 15 minutes. Check water level and refill if necessary. If okay, check that pumps have been primed. Press any button to reset.

dY: Inadequate water detected in heater. Spa is shut down. Follow directions for dr" message.

MAINTENANCE

WEEKLY MAINTENANCE

1. **Removing Debris**
Remove any debris and leaves from the Vortex skimmers and suction guard(s) on the inside of the spa. Blocked intakes can impede the flow of water through the jetting system.
2. **Water Level**
Replenish the water level if necessary so that it is approximately two-thirds up the Vortex skimmer opening. (See STARTING YOUR SPA.) Low and high water levels can damage your spa. It is important to check your water level often.

MONTHLY MAINTENANCE

1. **Filter Care**
We cannot stress enough the importance of a clean filter for proper water filtration. Dirty filters can restrict water flow, cause hazy water, and prevent your chemicals from working properly. Dirty filters can also cause low flow from jets, poor water clarity and sensors to activate error codes. It is important to clean filters regularly. Many water treatment products clear or clarify the water by clumping microscopic particles and minerals together so that these larger particles can be effectively trapped in the filter. A filter clogged with debris and calcium deposits does not trap particles properly.

The Maintenance Reminder on the spa-side Control Panel indicates a CL every 30 days to remind you to clean your filter.

EVERY THREE TO FOUR MONTHS

Leakage Detection

Open the equipment door and check for signs of water leakage around the pump(s). Pump seals wear out over time, especially with improper water chemistry. Early detection of pump seal failure can significantly reduce repair costs.

Ozonator Operation

The ozonator functions whenever the system is running on filter or clean up cycles. Check to see if the bulb is lighted. The end cap of the ozonator should glow if functioning properly. If not, the bulb has burned out. Contact your dealer for service.

Draining and Filling the Spa

On average, a spa needs to be drained every three to four months. After months of continually adding chemicals to the water and introducing body oils and lotions, the water can be difficult to manage and chemicals are not as effective as usual. You may also notice excessive foaming. More frequent draining may be required depending on use.

Draining the Spa

- A. Turn off the power to the spa.
- B. Open the equipment compartment (see EQUIPMENT DIAGRAM). Remove the hose bib cap from the connection and attach a hose.
- C. Open the drain valve. Gravity causes the water to drain out of the hose.
- D. When the spa is empty, close the drain valve and remove the hose. Reinstall the hose bib plug.

NOTE: Keep the drain valve closed at all times except when draining the spa (do not rely on the cap to stop the flow of water). Not doing so could result in damage to the drain valve due to freezing water.

AS NEEDED MAINTENANCE

Cover Care

Proper care of the cover increases the life and keeps it looking great in even the harshest conditions. **NOTE:** Do not use regular household products or products that contain silicone, alcohol, steel wool, or bleach.

Synthetic Exterior Care

Clean the exterior of the spa with a mild soap and water solution. Cleaners that contain alcohol or high levels of solvents, along with Acetone, Nitrobenzene, and Cyclohexanol, can dissolve and discolor the synthetic exterior.

Clean the Acrylic Interior

Once the spa is drained, clean the acrylic interior thoroughly – especially at the water line. Bleach (diluted) is the recommended cleaning agent for acrylic – other products should be avoided except as stated below.

To maintain the high gloss, elegant look of LUCITE XL just follow these simple steps: Use common household, non-abrasive cleaners for most cleaning jobs. For normal care and cleaning use a soft cloth or sponge with soap and water. Rinse well and dry with a soft, clean cloth. If using a household cleaner, make sure it is recommended for use on acrylic by the manufacturer. Never use abrasive cleaners. Do not allow your acrylic surface to come into contact with products such as ketones or esters such as acetone or ethyl acetate (nail polish remover), Wintergreen oil (methyl salicylate), nail polish, dry cleaning solution or other chlorinated organic solvents, lacquer thinners, gasoline, aromatic solvents, pine oil, etc. Remove dust and dry dirt with a soft, damp cloth. Clean grease, oil, paint and ink stains with isopropyl (rubbing) alcohol. Dry with a clean, soft cloth. Avoid using razor blades or other sharp instruments that might scratch the surface.

NOTE: Due to the high-gloss, fine finish of the acrylics, imperfections in the surface texture may occur. A natural aging process in acrylic can lead to a process called crazing. Fine spider web-like lines can form on the cosmetic surface of acrylic over time after exposure to the elements and chemicals. Crazing represents no structural weakening of acrylic and is not covered under the warranty. Fading, staining and discoloration may also occur but represent no structural degradation and are not covered under warranty.

NOTE: Do not leave an empty spa uncovered. Direct sunlight on the spa surface can cause severe damage or blemishing and can result in the voiding of any surface warranties.

Excess Debris

Grit and debris tracked into the spa should be removed with a spa vacuum.

Water Line

To avoid buildup of oils and lotions at the water line, clean the interior when needed. We suggest the *Glove Sponge* to clean without scratching.

NOTE: Do not use the same brush or sponge to clean the exterior of the spa and the interior of the spa. Soap and other product residue used on the outside of the spa can cause foaming of the spa water and scratches to the spa surface.

Light Bulb Replacement

- Turn off the power to the spa.
- Remove the equipment area door to find the light access. (See EQUIPMENT DIAGRAM.)
- Remove the lamp socket from the back of the light assembly by turning counterclockwise and pulling at the same time.

SUSPENDED USE OR WINTERIZING THE SPA

If you decide to discontinue the use of your spa for any extended period of time, we suggest you follow the steps below.

NOTE: During long periods of inactivity, damage can occur to equipment from condensation within the equipment compartment.

- Turn off the power to the spa.
- Drain the spa. (See DRAINING AND REFILLING THE SPA.)

- Remove all residual water from the seating and footwell. If necessary, bail out the remaining water then dry the spa with towels. A wet/dry vacuum is recommended for best results.
- Using the wet/dry vacuum, place vacuum nozzle over each jet nozzle to remove water from plumbing lines, starting with the highest jet and finishing with the lowest jet.
- Unscrew the pump plug(s) from the pump(s). (See STARTING YOUR SPA.)
- Again, using the wet/dry vacuum, place nozzle over the exposed pump opening(s) to remove excess water. The pump(s) should be removed from the spa and stored in a climate-controlled room.
- Clean the spa interior.
- Clean the filter cartridges.
- Reinstall the spa cover and lock in place.

NOTE: Direct sunlight on the spa surface can cause severe damage or blemishing and can result in the voiding of any surface warranties.

IMPORTANT CHEMICAL SAFETY PROCEDURES

- Always keep chemicals out of reach of children.
- Read product labels carefully prior to use.
- When dissolving, always add chemicals to water, do not add water to chemicals. Some dry chemicals should be dissolved prior to adding them to the spa. Using a clean container, dip some water from the spa. Mix until dissolved, then add to circulating water.
- CAUTION:** Do not mix chemicals together. Add them separately to the spa water.
- All chemical products should be stored in a cool, dry, well-ventilated area where the average temperature does not exceed 90°F (32°C). Keep storage area clean of debris such as rags, newspaper, and combustible materials.
- Keep chemicals away from open flame or other heat source. Do not smoke near chemicals. If a dry chlorine chemical fire should occur, use water only. Do not use a dry chemical fire extinguisher to attempt to put out the fire.
- When adding chemicals, always keep the water circulating in the spa with jets in a downward circular pattern for better chemical distribution. Add chemicals to the spa water one at a time. Allow several minutes between any new chemical additions using the jet action to evenly distribute throughout the spa.
- After adding chemicals, wait the amount of time recommended on the chemical container before retesting your water for an accurate reading. Retest your spa water before using.
- If you have any questions or concerns about the correct procedures for handling chemicals, please contact your authorized dealer.

WATER CARE

There are three things necessary for clean safe water:

- CIRCULATE:** Water has to be circulated regularly; it can not be stagnant.
- FILTER:** Water has to be filtered to remove particulate and debris.
- SANITIZE:** Water has to be sanitized to kill organisms like algae, bacteria and virus.

The control system in your spa will automatically circulate and filter. (See SPA CONTROL OPERATION.) The sanitation requires minimal effort if done consistently and properly.

To sanitize spa water, three things are required:

- BALANCE:** The water must be balanced so the sanitizer can work and spa equipment is protected.
- SHOCK:** Shock to oxidize organics and maximize sanitizer efficiency.
- SANITIZE:** Maintain a proper level of sanitizer at all times.

WATER CARE TROUBLESHOOTING

P: Problem

S: Solution

Cloudy Water

P: Inadequate filtration or dirty filter.

S: Ensure that the filter is securely installed. Clean or replace filter. Increase the length of clean up and/or filter cycles.

P: Water is not balanced.

S: Test water and adjust pH, alkalinity, and sanitizer as needed. Shock to oxidize and destroy organics in the water.

P: Unfiltered particles or chemically saturated.
 S: Use *Water Clarifier* to combine particles.
 P: High total dissolved solids
 S: Drain, clean, and refill the spa.

Chemical Odour

P: Too many chloramines/bromamines in the water.
 S: Treat water with *Spa Shock* then adjust sanitizer level as necessary.
 P: Dull looking water, difficult to manage. High total dissolved solids (TDS) may be the cause.
 S: Drain and refill with fresh water.

Musty Odour

P: Not enough sanitizer in water – bacteria or algae in water.
 S: Add sanitizer as necessary and shock. Readjust sanitizer level if necessary.

Yellow Water

P: Low pH and/or low alkalinity.
 S: Test and adjust pH with *pH and Alkalinity Up*. Adjust alkalinity if necessary.

Foaming

P: High concentration of body oils, lotions or soaps, as well as excessive organics.
 S: Use *Spa Defoamer* and adjust pH and sanitizer as needed.

Scum Line in Spa

P: Body oils and dirt.
 S: Use *Glove Sponge* to clean the spa. Test and adjust the sanitizer and pH if necessary. Increase the clean up cycle.

No Sanitizer Reading

P: Sanitizer level is too low.
 S: Shock until the sanitizer registers in the recommended range.
 P: Test strip remains "white" even after sanitizer has been added.
 S: Sanitizer level could be extremely high. It can bleach the reagents on the test strip and give a false reading. Remove spa cover and activate jets and air control. Allow jets to run for 30 minutes. Test water to see if desired level has been reached.

High Sanitizer Reading

P: Too much chlorine or bromine added or dispensed into the spa.
 S: Remove spa cover and activate jets and air control. Allow jets to run for 30 minutes. Test water to see if desired level has been reached. Reduce bromine level.

Eye or Skin Irritation

P: Contaminants or excessive amount of chloramines/bromamines in water.
 S: Treat water with *Spa Shock*. Adjust sanitizer level.
 P: pH is low.
 S: Adjust as needed.

Corrosion of Metal

P: Low pH.
 S: Adjust pH with *pH and Alkalinity Up*.

Green Water/Algae

P: Low sanitizer level or high pH.
 S: Adjust pH and shock as necessary.

Erratic pH

P: Alkalinity and/or calcium hardness are too low causing pH "bounce".
 S: Test and adjust alkalinity and/or calcium hardness to bring them into the ideal range.

DURAWOOD STEP INSTALLATION (OPTION)

The DuraWood step and mounting brackets may be placed along a straight side of the spa, most often centered to the entry location.

Find the center of the spa side where you want to mount the step. Measure 27.5" center spread and mark. Measure 1" up from base and mark.

- With step mounting brackets facing outwards, mark the two holes.
- Using the bracket as a guide, predrill two holes per bracket.
- Attach the left and right brackets to the spa exterior base.
- The step hardware is factory-installed. Loosen the thumbscrew. Gently push step towards the spa until the brackets and hardware engage.
- Tighten the thumbscrew to attach the step to the spa exterior.

NOTE: All steps can be inherently dangerous. Always use caution in stepping in and out of your spa.

LIMITED WARRANTY

WHAT THE MARQUIS CORP. LIMITED WARRANTY COVERS

Marquis Corp. warrants that our products will be free from defects in materials and workmanship for the term set forth exclusively in this warranty. Accessories purchased from Marquis Corp. or a Marquis Corp. authorized dealer and added to the spa after manufacture of the spa are not covered under this warranty but may have other warranties. Refer to owner's manual for proper use, maintenance and installation of your spa. The Limited Warranty is made only to the original purchaser of the spa and is not transferable.

- [10] **STRUCTURE:** The fiber glass structure is warranted for ten years not to leak. Fittings and attachments are not included.
- [7] **SURFACE:** The acrylic surface is warranted for seven years against blisters, cracks and delamination.
- [5] **PLUMBING:** Plumbing and fittings are warranted against water loss for five years. Warranty coverage does not include gaskets or seals.
- [5] **EQUIPMENT:** Electronic equipment is warranted against defects in materials and workmanship for five years. Equipment includes equipment packs, PC boards, pumps, control panels, heater and heat sensors.
- [5] **EXTERIOR:** The synthetic skirt exterior is warranted against cracking and peeling for five years.
- [2] **COMPONENTS:** The ozonator and GFCI are warranted against defects in material and workmanship for two years.
- [1] **PARTS:** LED lights, remote controls, valves, spa cover, stereo components, jet inserts and overlays are warranted for one year. These parts do not qualify for labor coverage under this warranty. Fuses, non-LED lights, filter, filter lid, cushioned headrests and other items not specifically mentioned in this warranty are warranted to be free from defects in materials and workmanship at time of delivery. These parts do not qualify for labor coverage under this warranty.

TERM OF THE MARQUIS CORP. LIMITED WARRANTY

The term of your warranty begins on the date the product is sold to you and continues for the term described in this warranty for each component.

WHAT YOU SHOULD DO IF YOU EXPERIENCE A PROBLEM

Unless otherwise designated in writing by Marquis Corp., Marquis Corp. or its agent are the only parties authorized to perform warranty service on Marquis Corp. spas. Upon experiencing a problem, please contact your authorized dealer. You will be asked to provide the following information when requesting warranty service: your name, address and contact information; serial number; a description of your spa and a description of the problem. You will be required to provide proof of purchase of your spa prior to receiving warranty service.

WHAT MARQUIS CORP. WILL DO IN THE EVENT OF A PROBLEM

Marquis Corp. agrees to repair any plumbing or surface defects and to repair or furnish a replacement for any factory-installed component covered under this warranty which, upon test and examination by Marquis Corp., proves to have manufacturing defects. All materials for examination must be returned to Marquis Corp. freight prepaid. Marquis Corp. will provide parts and labor where applicable (according to predetermined schedule) at no charge to repair or replace components that fail due to manufacturing defects. Responding authorized dealer may charge additional service and travel fees. In the event that Marquis Corp. or its agent determines that your problem can be addressed by providing a replacement part to you for installation in your spa, a replacement part will be provided to you at no charge when you return the defective part. All replacement parts assume the original warranty status of the spa into which they are installed, including time remaining on warranty, and have no separate or independent warranty of any kind. To facilitate repairs, Marquis Corp. or its agent may require access to spa equipment. It is your responsibility to provide unencumbered access.

WHAT THE MARQUIS CORP. LIMITED WARRANTY DOES NOT COVER

No warranty will apply to any spa that has been (i) modified, altered or adapted without Marquis Corp.'s written consent; (ii) maltreated or used in a manner other than in accordance with the spa owner's manual; (iii) repaired by any third party not authorized by Marquis Corp.; (iv) improperly installed by any party; (v) used with equipment not covered by this warranty, to the extent that problems are attributable to such use; (vi) relocated to the extent that problems are attributable to the relocation; (vii) located on any support surface other than specified in the spa printed instructions; and (viii) damage caused by pH level

outside the range of 7.4 to 7.6 and other chemical abuse. Refer to instructions in the owner's manual for proper use, maintenance and installation of your spa. Other items not included in this warranty are freight expenses; labor and material cost associated with removal and or replacement of the spa; damage to or fading of the spa surface and staining of the spa surface or equipment caused by impact, scratching, abrasive or corrosive cleaners; damage due to extreme water temperatures outside the range of 32°F to 120°F (0°C to 49°C) even if the damage was the result of a covered failure; or damage to the spa surface or equipment caused by acts of nature, including wind and power surges. Damage to the spa surface and fittings caused by leaving the spa uncovered and empty of water with direct exposure to sunlight may cause solar heat distress and also invalidates this warranty.

Other costs not associated with the direct repair of the spa, such as phone charges and missed work are not included in this warranty. In the event that the Marquis Corp. serial number tag on the spa has been removed or tampered with, the warranty will be void. Customer may not dismantle spas, and any attempt to dismantle systems, other than described herein, constitutes a modification or alteration of the spa which voids the applicable warranty.

LIMITATIONS

Your sole and exclusive remedy and Marquis Corp.'s entire liability in connection with manufacture and sales of its spa products is repair or replacement (at Marquis' option) of a defective part, as expressed in the limited warranty. Any other express or implied representation or warranty, including the implied warranties of merchantability and of fitness for a particular purpose as well as non-infringement, is excluded to the maximum extent permitted by law. Except as may be required by applicable law, Marquis Corp. shall not be liable for injury, loss, or damage to person or property, however arising, in connection with manufacture or sale of its spa products. This includes indirect, punitive, special, incidental, or consequential damages (including but not limited to loss of use) whether the claim for such injury, loss, or damage is based on breach of contract, breach of warranty, or tort, even if Marquis Corp. has previously been advised of the possibility of such damages.

This limited warranty gives you specific legal rights, and you may also have other rights which vary from state to state.

ADAGIO™ AUDIO SYSTEM AND AQUAVISION ONE YEAR LIMITED WARRANTY

Marquis Corp. warrants to the original retail purchaser, the components of the Adagio™ audio system or Aquavision unit will be free from defects in material and workmanship for a period of one year from date of purchase. One year coverage includes parts. Labor is covered for 90 days and is based on a predetermined schedule. Optional remote and IR/RF sending unit not included in this warranty: other warranties may apply from the original manufacturer of the optional remote. The Adagio™ audio system and Aquavision unit Limited Warranty is made only to the original purchaser of the spa and is not transferable. In no event shall any obligation of Marquis Corp. extend beyond the original period of any applicable warranty determined according to the effective warranty date of the original purchaser.

PERFORMANCE OF WARRANTY

Marquis Corp. agrees to repair or furnish a replacement for any defects in Adagio™ audio system or Aquavision unit material or workmanship which upon test and examination by Marquis Corp. proves defective. Adagio™ audio components including CD player/radio, speakers, subwoofer, mechanical speaker lift device, stereo access door, power supply are warranted against defects in material and workmanship for one year. Aquavision components including mechanical monitor lift device, monitor housing and power supply are warranted against defects in material and workmanship for one year. Labor to replace audio or Aquavision components is covered for 90 days. Water intrusion of any kind is not covered. All materials for examination must be returned to Marquis Corp. freight prepaid. Your authorized Marquis Dealer reserves the right to assess travel charges for service calls.

INVALIDATION OF WARRANTY

This warranty is void if the Adagio™ audio system or Aquavision unit has been subjected to alteration, misuse or abuse or if any repairs on the Adagio™ audio system or Aquavision unit are performed or attempted by anyone other than an authorized Marquis Corp. service center. Alteration is defined as any component change, electrical conversion or the addition of any alternative sound system components which contribute to component failure.

Misuse and abuse shall include without limitation any external power source attached to the Adagio™ audio system or Aquavision unit other than approved source, or use in a particular manner that the Adagio™ audio system or Aquavision unit was not designed, or operation of the Adagio™ audio system or Aquavision unit other than in accordance with Marquis Corp. printed instruction (located in the Owner's Manual) that leads to any component failure. Under no circumstances shall Marquis Corp. or any of its representatives be held liable for injury to any person or damage to any property, however arising.

Other costs not associated to the direct repair of the spa, such as phone charges, missed work, and damage caused to the Adagio™ audio system or Aquavision unit beyond Marquis control, are not included in this warranty. Items beyond Marquis control include but are not limited to damage resulting from: improper connections, accidents, failure to follow procedures defined in the Owner's Manual, damaged from excessive wattage to the system, lightning, extreme temperatures or any other natural occurrences.

IMPORTANT: Some jurisdictions do not allow the exclusion or limitation of incidental or consequential damages, therefore the limitation or exclusions may not apply to you.

DISCLAIMERS

There are no additional warranties, express or implied, which extend beyond the terms of this limited warranty. Marquis Corp. makes no warranty of merchantability of the goods or the fitness of the goods for a particular purpose. No other person or entity has been authorized to make any warranty, representation or promise of performance not included in this express written warranty, and Marquis Corp. shall not be bound by any such additional warranty, representation or promise.

This warranty gives you specific legal rights. You may also have other rights that may vary from state to state.